

IDM UID WEH9QD
VERSION CREATED ON / VERSION / STATUS 27 Apr 2018 / 1.1 / Approved
EXTERNAL REFERENCE / VERSION

Technical Specification

TCC1 Technical Summary for CFN

This document gives an high level overview of the scope of TCC1 contract for CFN purpose.

<i>Approval Process</i>			
	<i>Name</i>	<i>Action</i>	<i>Affiliation</i>
<i>Author</i>	Targa R.	27 Apr 2018:signed	IO/DG/COO/CST/TCS
<i>Co-Authors</i>			
<i>Reviewers</i>	De Cat W. Dees-Sims A. Olcese M.	27 Apr 2018:recommended	IO/DG/RCO/FPD/PCD/CAL IO/DG/RCO/FPD/PCD/CAL IO/DG/COO/PED
<i>Previous Versions</i>	Di Giuseppe G. Yan Q.	24 Apr 2018:recommended v1.0 20 Apr 2018:recommended v1.0	IO/DG/COO/PED/FEID IO/DG/COO/CST/TCS
<i>Reviews</i>	Rafin L.	24 Apr 2018:recommended v1.0	IO/DG/RCO/FPD/PCD
<i>Approver</i>	Murphy S.	27 Apr 2018:approved	IO/DG/COO/CST/TCS
<i>Document Security: Internal Use RO: Kotamaki Miikka</i>			
<i>Read Access</i>	LG: Contract/Finance for CMA, LG: TCC1 Tender Project Team , AD: ITER, AD: External Collaborators, AD: IO_Director-General, AD: EMAB, AD: OBS - Tokamak Complex Section Division (TCS), AD: OBS - Construction Management Division (CMG), AD: Auditors, project administrator, RO		

Change Log

TCC1 Technical Summary for CFN (WEH9QD)

<i>Version</i>	<i>Latest Status</i>	<i>Issue Date</i>	<i>Description of Change</i>
v1.0	Signed	20 Apr 2018	
v1.1	Approved	27 Apr 2018	Comments implemented

Table of Contents

1. Purpose	2
2. Abbreviations	2
3. General Statement	3
3.1. Staged approach	3
3.2. Construction Areas	4
3.3. Structure.....	5
3.4. Scope of activities.....	6
4. Interfaces with other companies.....	8
4.1. Boundary between Worksite 1 and Worksite 2	8
4.2. Workshops	9
4.3. Interfaces to Other Contracts	9
4.3.1. Interfaces to IO WS2 Contractors	9
4.3.2. Scaffolding.....	10
4.3.3. Lifting.....	10
5. Required Competences	11

Technical Summary

Tokamak Complex Installation Works TCC1 Contract

1. Purpose

The purpose of this document is to provide a high level summary of the scope of works, strategy, and required Contractor competences for the Tokamak Complex Contract (TCC1), covering the pre manufacturing, assembly and installation works inside the Tokamak Complex Area (WS2) and outside the Tokamak machine boundary (WS1) of the ITER project based in Saint Paul Lez Durance, France.

2. Abbreviations

The following table lists and defines the abbreviations used in this document.

Abbreviation	Definition
ASN	Autorité de Sûreté Nucléaire
CMA	Construction Management as Agent
CWP	Construction Work Package
DA	Domestic Agency
E&IC	Electrical, Instrumentation and Control
ESPN	Equipements Sous Pression Nucléaire (Nuclear Pressure Equipment)
INB	Installation Nucléaire de Base (Basic Nuclear Installation)
IO	ITER Organization
IWP	Installation Work Package
M&P	Mechanical & Piping
NDT	Non Destructive Testing
PIA	Protection Important Activities
TAC	Tokamak Assembly Contract
TCC	Tokamak Complex Contract
WS	Worksite

Table 2.1 - Abbreviations and Acronyms

3. General Statement

3.1. Staged approach

Assembly of the ITER Tokamak is separated into four distinct phases; and the timeline for the first two Tokamak Assembly Phases is shown in Figure 3.1.1.

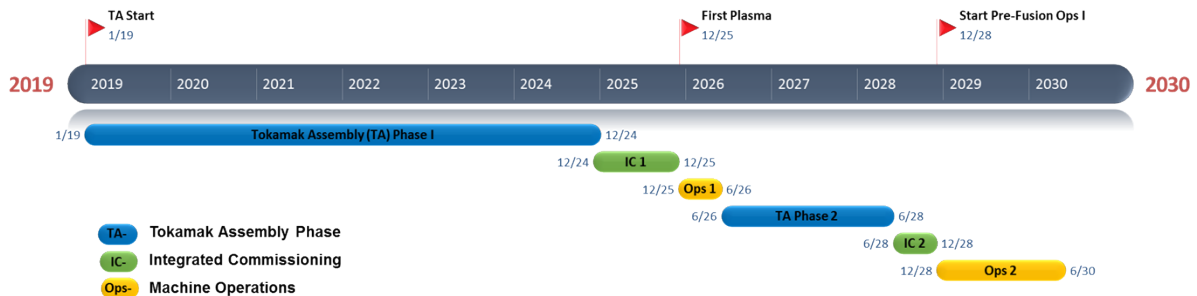

Figure 3.1.1 - Assembly Phases

- **Assembly Phase 1** includes the basic Tokamak machine with systems essential for First Plasma operation; the installations comprise permanent hardware, temporary equipment replacing permanent hardware, such as the main in-vessel components, and captive components that cannot be installed in later assembly phases.
- **Assembly Phase 2** includes the installation of the main in-vessel components, including the Blanket, the Divertor and coils. Heating systems will be installed and diagnostics systems will be added to support the research program. Preparatory activities for Assembly Phase 2 will occur during Assembly Phase 1. The contract strategy for this phase will be defined later.

The ITER Organization (IO) is already in the process of tendering for the Assembly Phase 1.

For Worksite 2, the IO plans to award three contracts TCC0, TCC1 and TCC2, to cover the whole scope of the Assembly Phase 1; the scope of these Contracts will cover all the Mechanical & Piping (M&P) and Electrical, Instrumentation and Control (E&IC) installation works of this area. This technical summary covers the TCC1 contract only.

3.2. Construction Areas

The works in the scope of the Contract are located on the ITER Platform currently under construction in Cadarache, Southern France. Central to the facility is the Tokamak Complex, a nuclear rated structure in reinforced concrete that comprises three integrated buildings, Figure 3.2.1. The Complex has a footprint of 118 x 81 m, extends vertically from -15 m to +40 m relative to ground level, and contains the plant systems that service (power, heat, cool, condition, fuel, monitor and control) the Tokamak machine.

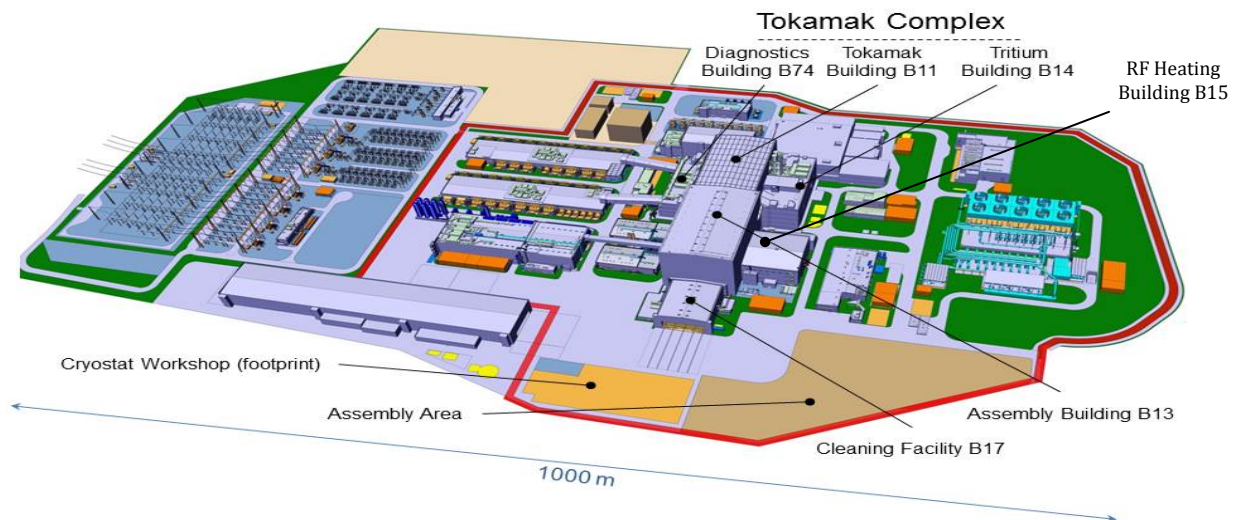

Figure 3.2.1 Site Overview – Future Final Configuration

The ITER site has been divided into 5 independent main worksites (WS). The worksites are defined to collect together groups of buildings and areas by major discipline, in order to better allocate works Contractors and suitably qualified persons. As presented in the Figure 3.2.2 below, the breakdown of the site and works is the following:

- WS1 - Tokamak Basic Machine (including Assembly and Cleaning Facility buildings)
- WS2 - Tokamak Complex buildings (excluding Tokamak Pit)
- WS3 - Other nuclear buildings and Control building
- WS4 - Cryogenic plant and Site Services buildings
- WS5 - Electrical Areas and Power Supplies Buildings

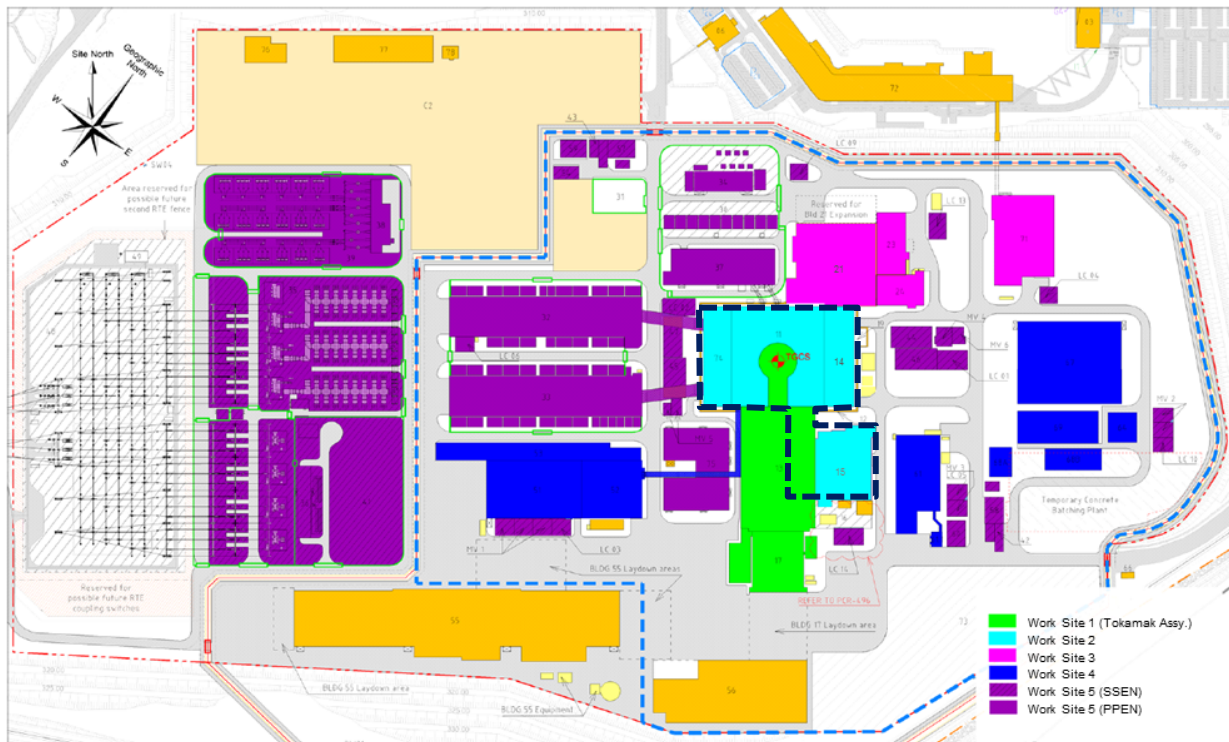

Figure 3.2.2 - Breakdown of the ITER Site and buildings to independent Construction Worksites.

The works in the scope of the Contract will take place in the WS2 and partially in the WS1 in the buildings indicated with dashed black line in the Figure 3.2.2. These are:

- Building 11 – Tokamak Building
- Building 14 – Tritium Building
- Building 74 – Diagnostic Building
- Building 15 – RF Heating Building

In addition, some minor works in the scope of the Contract are located in the Tokamak Assembly Hall (building 13) which belongs to the Worksite 1.

3.3. Structure

The IO, assisted by the Construction Manager as-Agent (CMA), will define the assembly process through Construction Work Packages (CWPs). Each CWP will define a package of works prepared and instructed to the Contractor by the CMA and performed by the Contractor as a unit, with a defined start and completion point and a required cost based upon the tendered unit rates for each type of work.

3.4.Scope of activities

The contract will include, but not limited to, the installation of the Phase 1 configuration of the following plant systems: Cooling Water, Diagnostic, Fuelling, Vacuum, Tritium pipes, Heating and associated electrical devices which are in IO scope for phase I configuration, or which IO executes on behalf of Domestic Agencies (DA). Refer to Annex for further details.

The scope of this contract includes various activities such as (refer to Annex for more details):

- Construction execution documentation to properly perform the construction works,
- The contractor shall issue all the necessary documentation required to undertake and to follow-up installation activities and to record all activities,
- Pre-manufacturing and Installation of pipework spools including related supports,
- Installation of pre-manufactured pipework spools including procured items from other DAs in the scope of IO,
- Installation of large/heavy equipment like pumps, compressors, heat exchangers, pressure vessels and valves,
- Preservation works,
- Installation of special components like cold boxes, gas valves boxes, pipe lines for cryo fluid, busbars.
- Installation of specific systems requiring special cleanliness, techniques or accuracy (e.g. fuelling lines, transmission lines, waveguides, vacuum lines),
- Procurement, pre-manufacturing and installation of steel platforms and structures fixed to the buildings for man access or for supporting components or pipes when procurement or installation is in the scope of IO,
- Cable harness pre-manufacturing, power, instrumentation and control cables pulling and termination,
- Procurement and installation of secondary cable trays and conduits,
- Procurement and installation of low voltage panels and junction boxes,
- Installation of the instrumentation and control cabinets which will constitute the process boundary (e.g. thermowells, in line instrumentation like flowmeters or others),
- Installation of access control and security equipment, electrical equipment and hook-ups,
- Installation Tests (e.g. NDT, pressure test, leak tests and vacuum tests, calibration, electrical tests),
- Finishing works (e.g. internal cleaning, touch-up paint, thermal insulation, cladding, labelling and tagging),
- Assistance during Start-Up and Pre-commissioning Activities,
- Assistance during commissioning activities performed by the IO or DA Operator of systems,

The Contractor shall also be responsible for the following activities:

- Provide any required temporary works including, but not only, the means of protection and the tools needed to properly manage and perform the different stages of work in the buildings and on site,
- IO will provide the needed scaffolding through a service contractor while the CMA will coordinate the services. The Contractor will be responsible for defining the scaffolding needs.
- Minor lifting and handling equipment required for the installation of the described items in Annex.
- Issue all necessary documentation for the works, such as Quality Plan. Health and Safety plan, workforce planning (Installation sequence and Level 4 Schedule) and the List of documents to be issued for the execution of the works.
- Provide the records of NDE's and all the information required to comply with regulation and applicable codes,
- Issue the As-Built dossier,
- Provide support during commissioning phase with a minimum number of resources (the duration and specific resources will be specified at the call for tender stage)
- Perform final installation tests (mechanical & electrical completion) and verifications, as described below:
 1. Mechanical completion of the Structural, Mechanical & Piping includes:
 - Verification that the piping systems, mechanical equipment and their supporting structure are correctly installed
 - Non-destructive examination
 - Hydrostatic tests
 - Technical cleaning (foreign material exclusion, dust control, flushing or others)
 2. Electrical completion of installed equipment includes:
 - Normal inspection of all cables, wiring & termination
 - Normal inspection of cable and tray support, tray (fill), grounding, integrity
 - Check of stress core installation for MV & HV cable
 - Check of bend radius of cables
 - Tests of continuity and megger testing (insulation)
 3. Completion for instrumentation systems includes verification and validation of the instruments and valves and its comparison with the original design data to assure their process flow condition will be met. This verification and validation include:
 - All wiring checked & verified
 - Inspection for continuity & insulation
 - Control system loop checking for confirmation (with specific mock-up)
 - Checking of boards, modules and cubicles.
 - Hydraulic & pneumatic tubing cleaning, flushing and pressure testing to assure that there are no leaks and that the cleanliness meets required quality.

NOTE: For some horizontal activities (e.g. handling, lifting, scaffolding, transport) the IO Works Contractor (TCC1) will have to interface with the companies awarded for these specific activities. The interfaces will be managed by the Construction Manager as Agent (CMA) under the surveillance of the IO.

The contractor shall execute works according to instructions, with pricing based upon tendered unit rates for each type of work.

All above mentioned works (except some pre-fabrication activities) shall be performed by the Contractor within ITER premises at Saint Paul-lez-Durance in France.

4. Interfaces and Resources

4.1. Boundary between Worksite 1 and Worksite 2

As described in section 3.2 and in figure 3.2.2 the works in the scope of the Contract take place in Worksite 2 (WS2) which includes Tokamak building 11. The physical boundary of the Tokamak Machine inside building 11 is, for the purpose of assembly and installation works, defined by the outer surface of the bio-shield. In general terms, this surface demarcates the Tokamak machine assembly works to be executed by the TAC Contractors (WS1) from the Tokamak Complex plant installation works to be executed by the TCC Contractors and others (WS2).

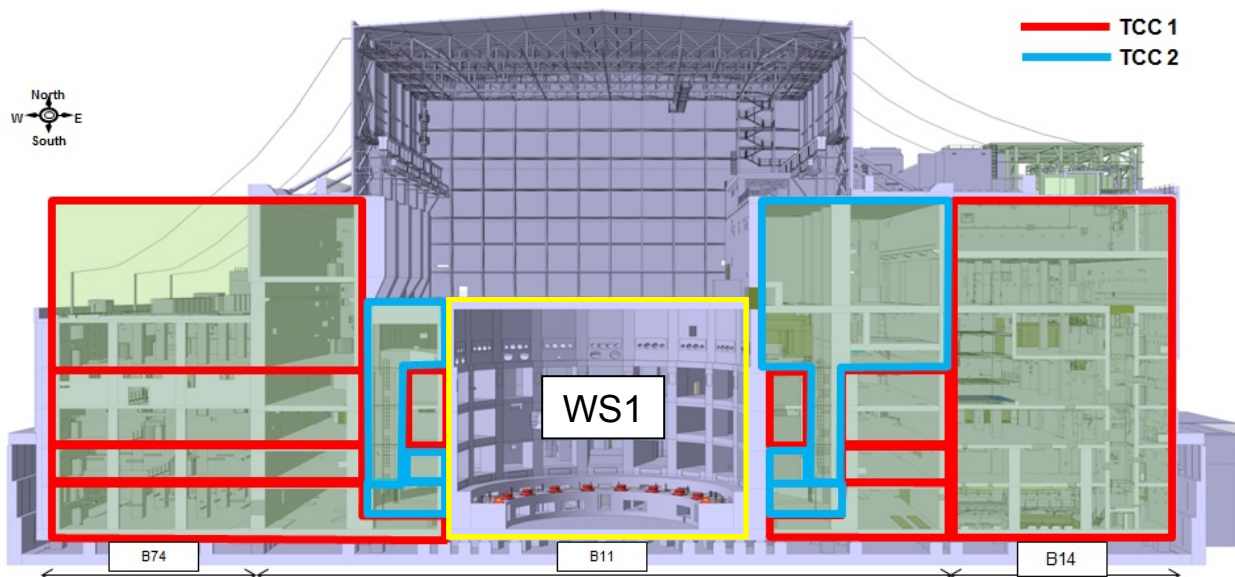

Figure 4.1.1. Physical boundary principle between WS1 and WS2 in the Building 11

It is expected some coactivity with other Contractors working on the ITER site around the Buildings and also inside the Buildings involved in these installation activities.

To manage the coactivity on site and the installation schedule, the IO is currently working with a Construction Management-as Agent (CMA). The CMA shall oversee these tasks on behalf of the IO:

- Project management,
- Works preparation,
- Site coordination (including permit to work),
- Material management,
- Work supervision, quality control, record keeping,
- Management of completion activities.

4.2. Workshops

The IO will provide an area dedicated to the Contractor for the installation of his site facilities, possibly covering a workshop, local storage, and some pre-assembly activities on smaller components. These areas will be located on the ITER Worksite platform. The areas will be connected to the potable water, IT and electrical networks as well as to the industrial drainage network.

To support the pre assembly activities, the Contractor shall provide a general workshop facility within the area described above and as appropriate to volume and schedule an off-site locally workshop to enable the pre fabrication and modification of pipe spools, steel structure, supports, insulation, temporary meanings, etc. These workshops shall be staffed by competent technicians, and have an acceptable selection of hand tools, machine tools, control instrumentation and welding equipment. Part of these workshops shall be segregated for carbon and stainless steel fabrication.

The contractor will be fully responsible for transport between the ITER site and these workshops, and for any ITER components while off-site.

On the site, ITER has available a number of buildings for component storage. In general IO special tools will be collected by the Contractor from these storage locations, and returned to them on completion of the corresponding CWP.

Due to the limited area available for the onsite workshop, not suitable for complete scope prefabrication, the contractor is responsible to provide his own workshop for main pipes, steel structures and supports prefabrication activities outside of IO site.

4.3. Interfaces to Other Contracts

4.3.1. Interfaces to IO WS2 Contractors

The Contractor may:

- Execute a CWP where the preceding CWP was performed by another contractor;
- Complete a CWP where the following CWP is performed by another contractor;

At the start of a CWP the Contractor will have an opportunity to examine and accept the components/environmental conditions, and at the end of the works, the completion will be certified by the IO with the support of the CMA.

4.3.2. Scaffolding

The IO will put in place a framework contract for the lease of scaffolding (scaffolding contractor). This contract will be for the provision of scaffolding to the Contractor and other IO works contractors.

Due to the high level of interaction between different contractors, the use of this scaffolding contract will be obligatory for all work being carried out in WS2 as several works contractors may use the same scaffolding. IO will pay the scaffolding contractor directly.

4.3.3. Lifting

In order to avoid that each Works Contractor places a separate subcontract for the hire of lifting equipment (mainly mobile cranes), IO had envisaged the obligatory use of a single contractor throughout the ITER Site (excluded Contractors areas and workshops).

The use of this framework contract shall be obligatory for the IO Contractors working in WS2. The IO will pay the lifting contractor directly but the responsibility for the lifting operation shall remain with the Contractor.

5. Required Competences

The competence and experience of the Contractor, and the ability, experience, and training of his engineering and construction team will have a direct influence on quality, re-work, and schedule, and ultimately on the performance of the Tokamak during operation; the Contractor will be required to demonstrate competence and experience in a number of key areas as listed in Table 5.1.

Area of Competence
Codes and Standards
Occupational Safety
Process Development and Qualification
Quality Assurance / Quality Control
Regulated construction
Process piping and equipment installation
Nuclear Pressure Equipment regulation
Vacuum pipes installation
Multi core pipes installation
Carbon and stainless steel welding process
Inspection and Non-Destructive Examination
Instrumentation Installation
Lifting and Handling
Tooling Maintenance, Storage and Preservation
Clean condition working
Cubicles installation
Cable pulling
Assembly of complex specialist equipment (Gyrotrons, wave guides, etc.)
Handling, placement and interconnection of specialist mechanical, electrical and electromechanical equipment to a high degree of accuracy (e.g. vacuum pumps; HV/MV equipment, cabling and Busbars; transmission lines).
Managment and execution of site works in highly regulated, complex, industrial/nuclear projects
Ability to comply with, the French Order of 7 February 2012, establishing the general rules for Basic Nuclear Installations
Experience in overall scope as described in section 3.4
Installation and installation testing of complex bespoke equipment including vacuum equipment
Execution of trials on mock-ups and development of detailed installation procedures

Table 5.1 Required Competences

***Tokamak Complex Installation Works
TCC1 Contract***

Overview of Scope of Work

Mechanical and Electrical Installation Works

TCC1: CCWS, CHWS, Diagnostic, Cables & Cubicles, ECH & CD, Tritium Pipes and a part of Vacuum and Fuelling

Overview of Scope of Work

List of Main Systems in the Scope of Work

- *Fuelling and wall conditioning system*
- *Cooling Water system*
- *Vacuum system*
- *Tritium Plant including Detritiation system (only piping and tanks)*
- *Ion Cyclotron Heating and current drive system*
- *Electron Cyclotron Heating and current drive system*
- *Diagnostics system*
- *Steel structure platforms for man access & support of equipment*
- *Cubicles and cables for systems in the areas*

Work Site 2 and buildings relevant for contractor's scope

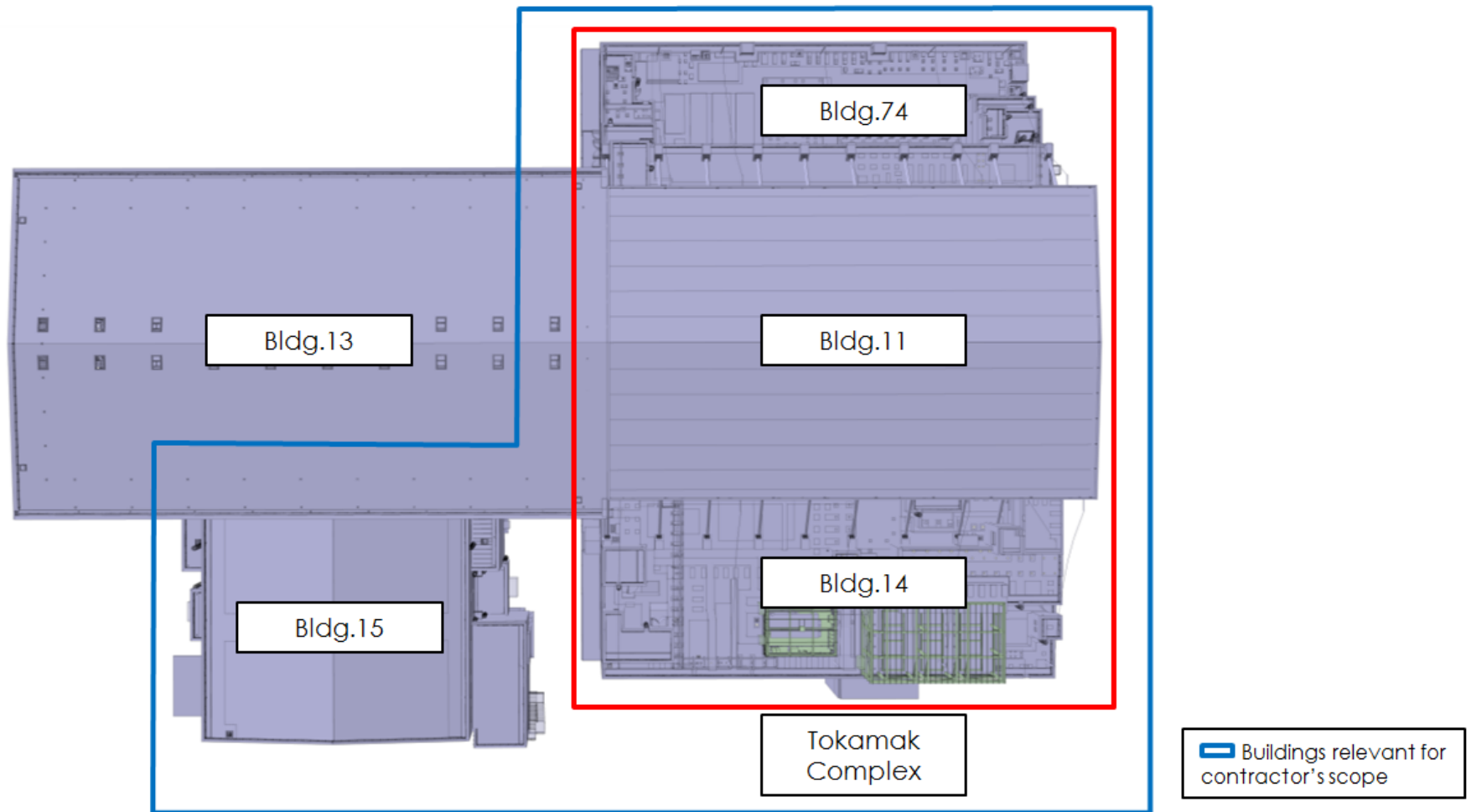

Tokamak Complex – Section view – Work Areas

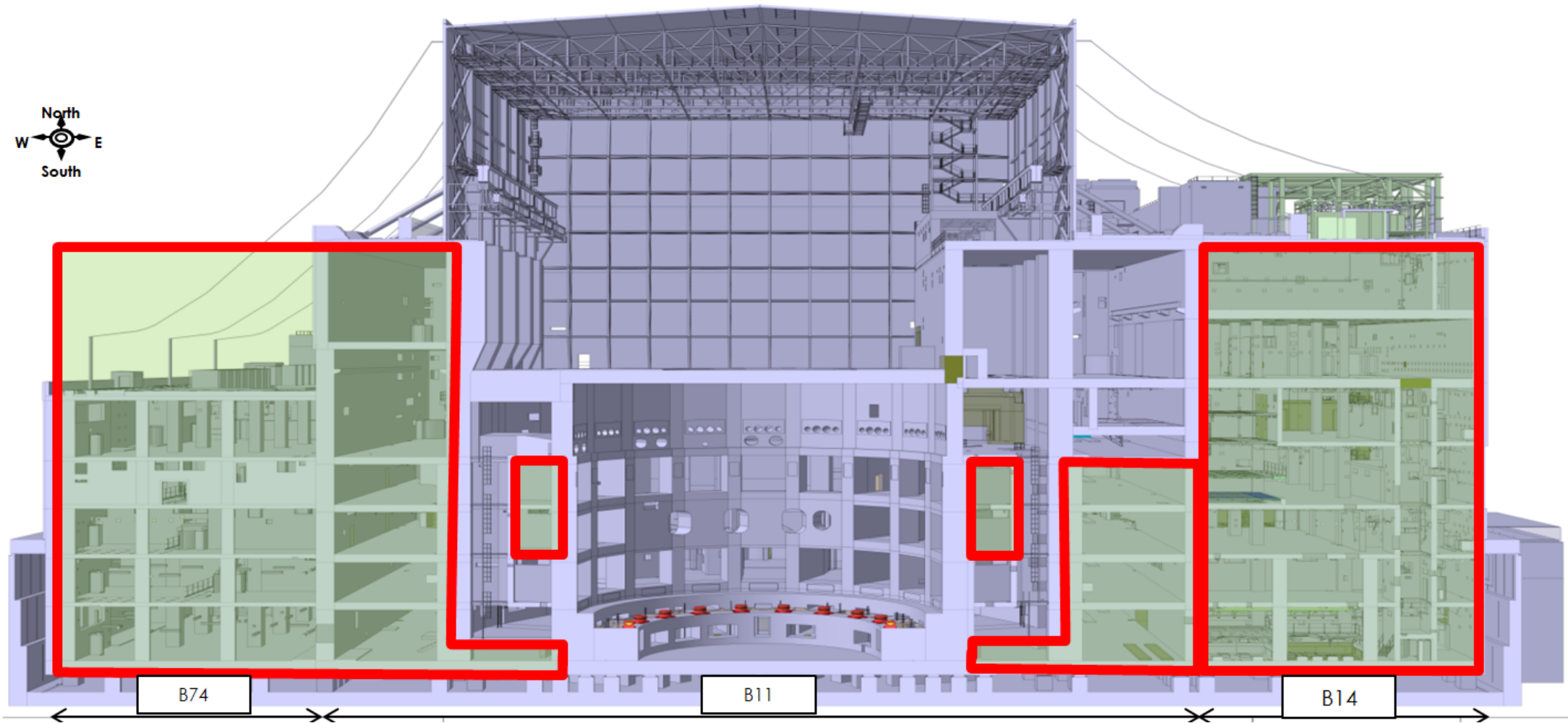

Tokamak Complex – Section view – Work Areas

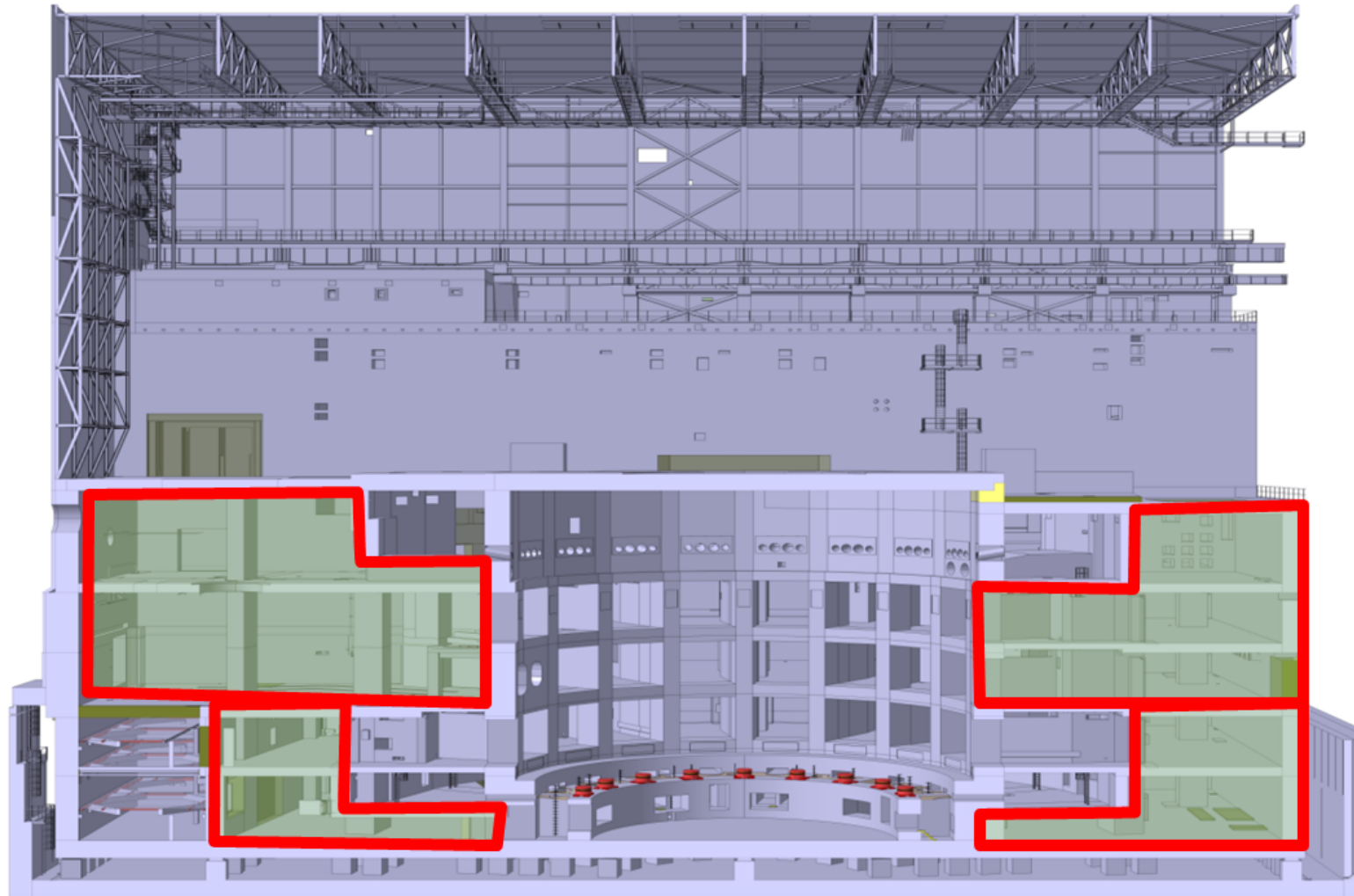

Fuelling network

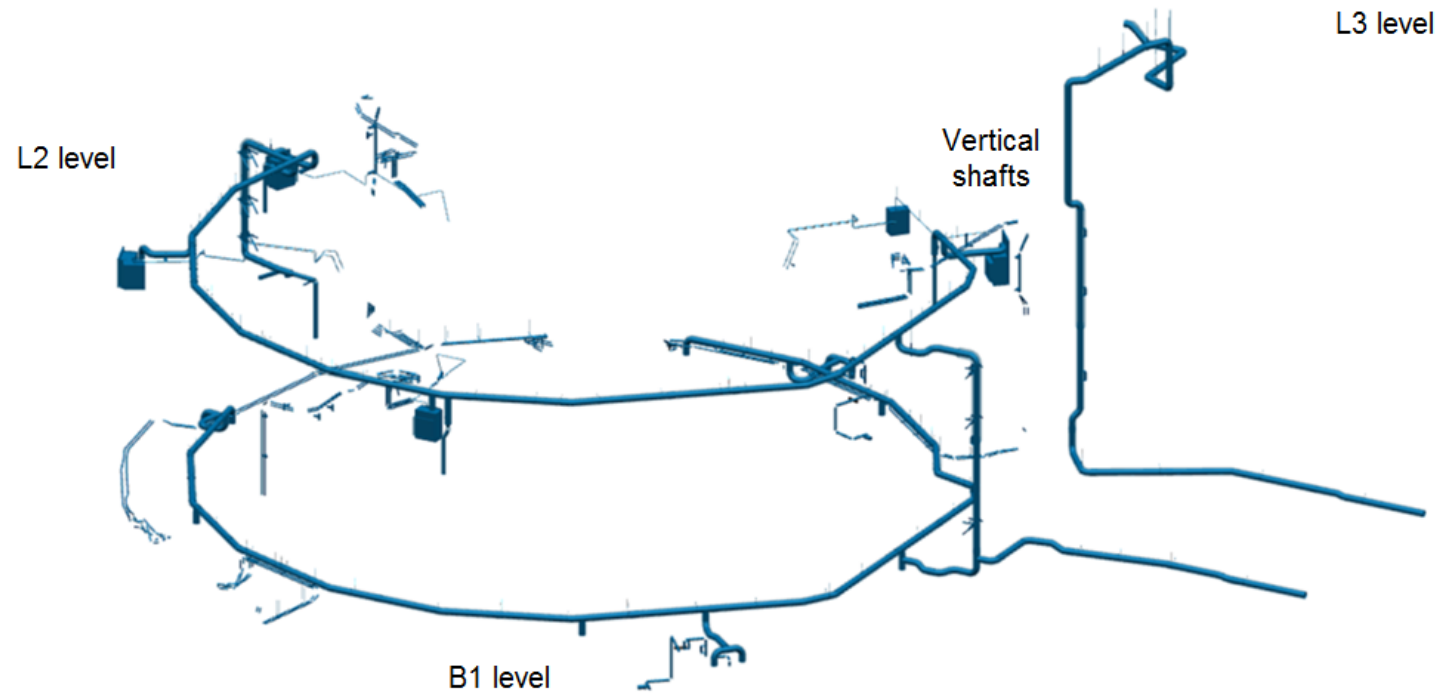

- DMS cryogenic line in Port Cells at L1 and L2 Level in Building 11
- 4 GFS Gas Valve Box in Port Cells at L2 Level in Building 11
- GFS leak detection box at B1 Level in Building 14
- FPSS in Port Cells at L2 Level in Building 11
- GDC equipment in Port Cells at L1 and L2 Level in Building 11

CCWS – CHWS

Component Cooling Water System (CCWS) Chilled Water System (CHWS)

Function: transfer heat from Tokamak and auxiliary systems to Heat Rejection System (HRS).

- Location: throughout the Tokamak Complex;
- Scope of work is limited to the installation inside of the Buildings;
- Scope of work includes pipe and supports prefabrication;
- Scope of work includes Cubicles, cables and E&I for pipes already installed in some area

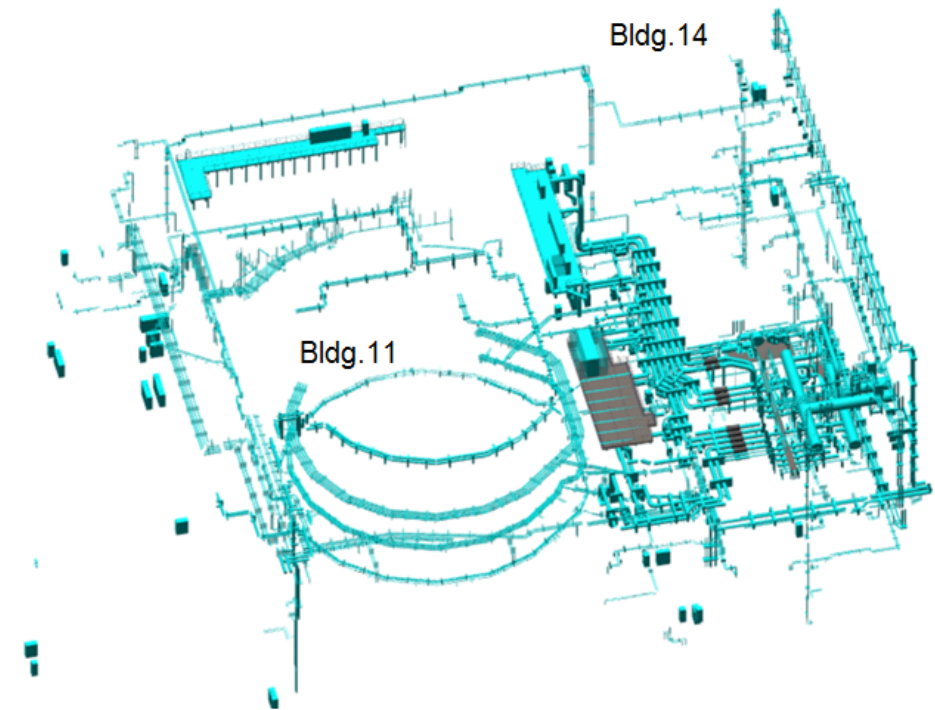

Total length about: 14,000 m Stainless Steel (440 ton of pipe work) in scope
The scope is split between TCC0/1/2 contracts depending on the area

Vacuum system – Vacuum pumping room

Roughing Trains

For the roughing of the Cryostat, Torus, Neutral beam, Absolute valve and Type 2 Diagnostic equipment, active and non active SVS, several roughing trains are foreseen. Each of these roughing train is composed by Screw pumps that back Roots pumps mounted into pumping train/skids (approx. 20 pumps).

Overview of leak detection system and gas analysis

The leak detection system is composed of leak detection units dedicated to Torus, NB, Cryostat, SVS and a gas analysis station; these components of the leak detection system will be delivered ready to be installed.

Condensable vapour devices (water trap)

4 units stand alone, delivered ready to be installed.

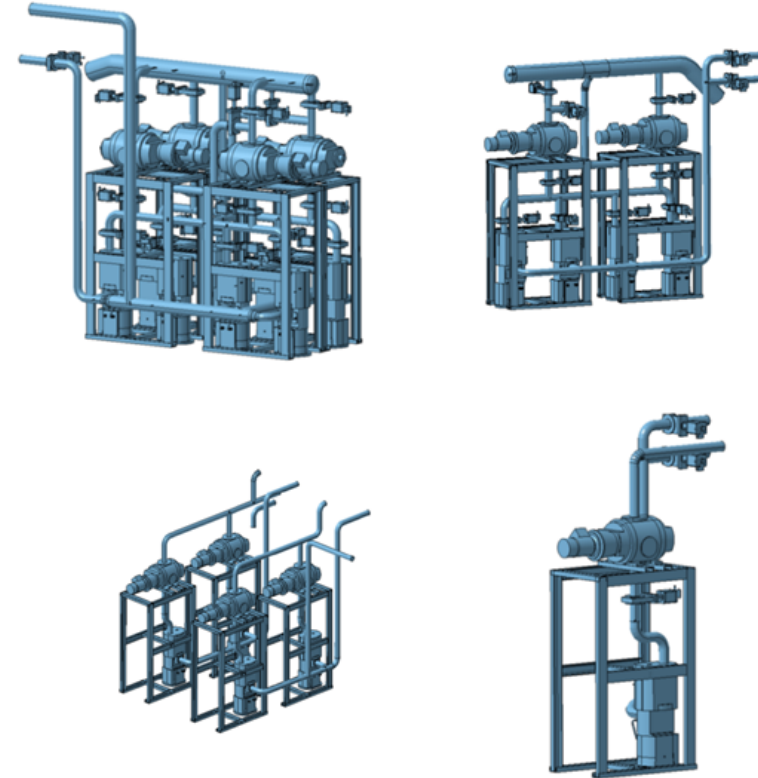

All pumps, pipework and valves are fixed inside or on top of a metal frame fabricated out of carbon steel. The frame is to be welded to the Embedded plates available on the floor of the room and the pumps to be bolted.

Vacuum system – CGVS and Dust filter

Cryo Guard Vacuum System

The CGVS is a distributed system across 68 locations which comprise of vacuum pumping units with embedded instrumentation, pipework, supports between pumping stations and its clients and remote control cubicle as well as back end components required for client pressure monitoring.

There are 68 CGVS units and associated connecting pipes in Building 11, level B2/B1/L3; building 14, level L1; and cryobridge.

Components to be installed are as follows;

- CGVS pumping unit
- associated pipe run connecting it to up to 4 clients

The scope is split between TCC1/2 contracts depending on the area

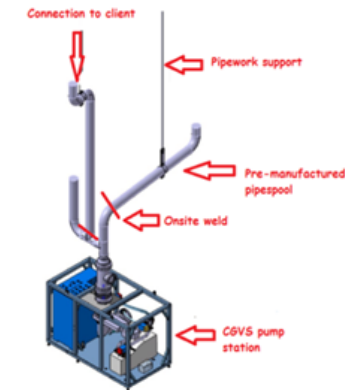

Dust filter units for NB Vessels and the Torus Vessel

Components to be installed are:

- 1 Neutral Beam Vessels Filter
- 3 Torus Vessel Filter
- 1 Secondary Filter

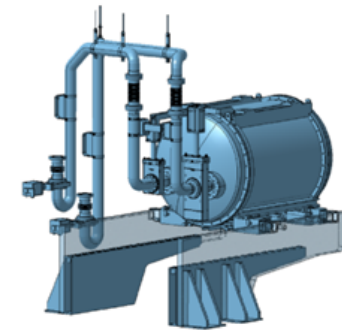
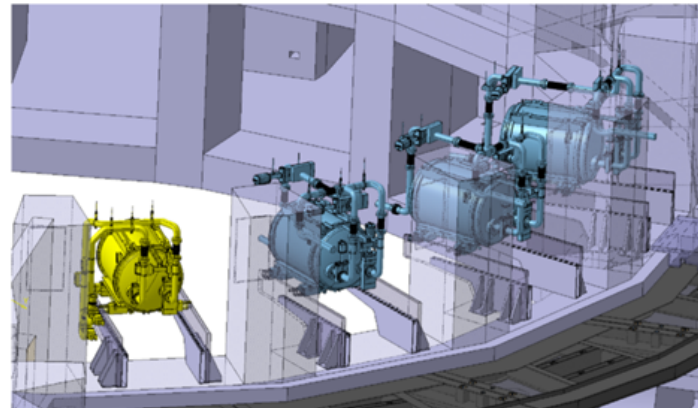
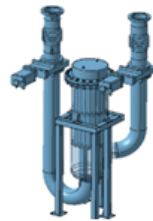

Vacuum system – EC Pumping and LDS

EC Pumping System

For first plasma 8 Turbo Molecular vacuum pumping systems are required for pumping of 8 transmission line waveguides in building 11-L2 in the gallery of port 16. In addition to 8 Ion pumping systems will be installed in building 15 at level 3. The general layout comprises of TMP pumps, IP pumps, valves, gauges, bellows, flanges and pipework which connect to the transmission lines and other clients in building 11 and 15 to provide continuous pumping of the waveguides.

Leak Detection Systems

Components to be installed are:

- The Torus (local) Leak Detection system, and Calibration system.
- The Neutral Beam (local) Leak Detection system
- The Cryostat (local) Leak Detection System.

The subsystems for each of the 3 local Leak Detection Systems are:

- A pumping manifold incorporating several turbo pumps and their isolation valves.
- A gettering system comprising a heated getter cartridge, and a number of valves
- A Mass Spectrometer Leak Detection system

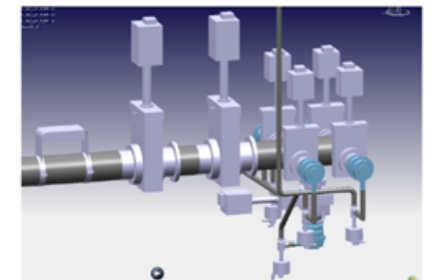
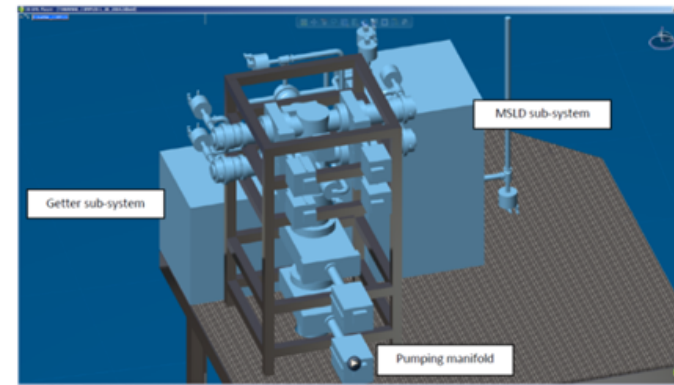
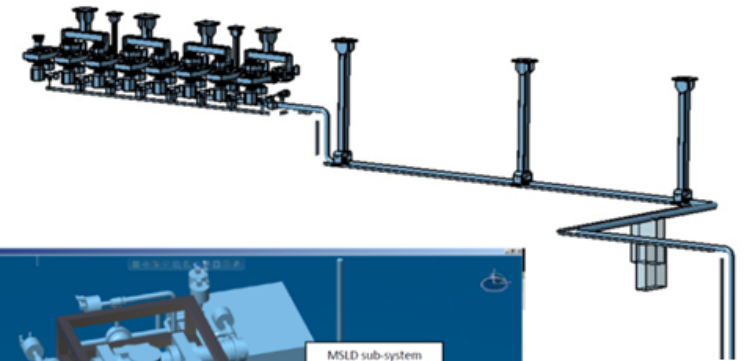
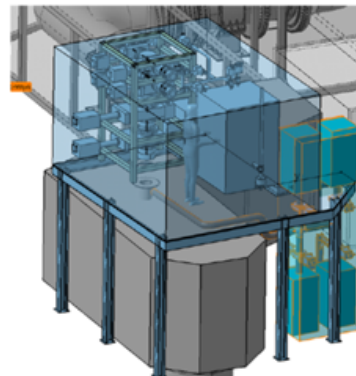

Vacuum system - Piping

Vacuum System Pipe Runs are required to interconnect vacuum systems of the ITER vacuum system. The pipe runs form a vacuum network distributed throughout the Tokamak complex. The scope is split between TCC0/1/2 contracts depending on the area

Vacuum manifolds:

Pipework component parts (tees, elbows, pipes, hangers, supports, etc.) to be manufactured and installed.

Vacuum connections to clients:

Vacuum components (valves, bellows, etc.) pre-manufactured to be installed

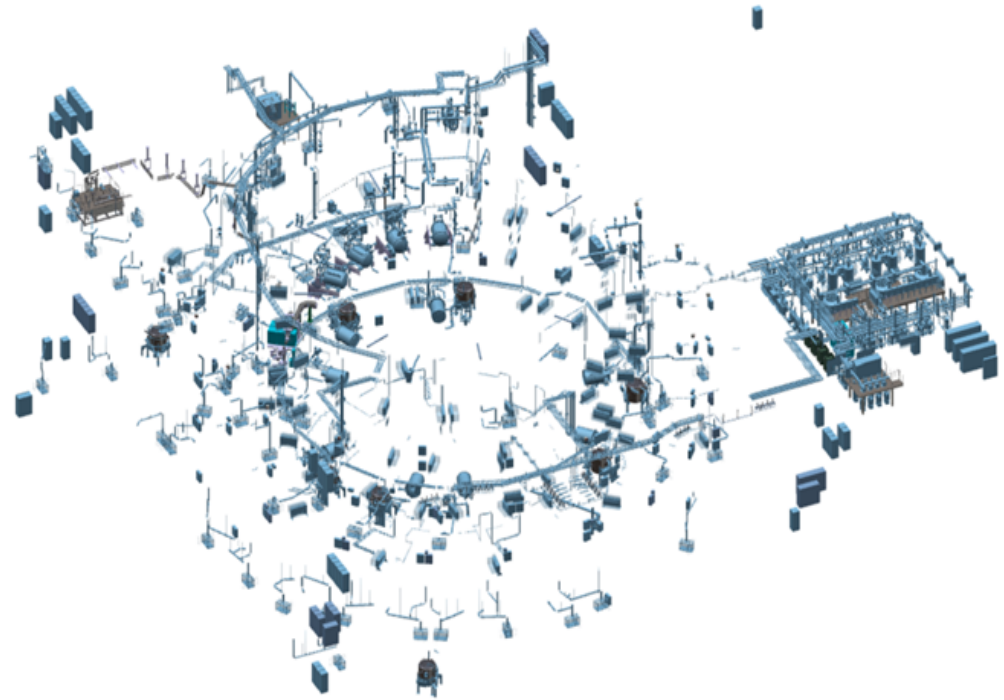

All the pipework components /Pre-manufactured Spools/Pipe Runs installation at IO under this contract shall comply with the French Order of 7th February 2012 establishing the general rules for licensed nuclear installations components .

Vacuum system – SVS Boxes and type 2 Diagnostic system

Distribution Boxes contain the pipework, valves and pressure gauges necessary to control and regulate these vacuum services to clients. These SVS distribution boxes are located in various locations in Bldg. 11 and 14. There are 79 individual box locations. Each Distribution Box consists of a Master Module that connects to Client modules of different sizes. There are three different sizes of client module, small, medium and large. Different combinations of client module are required depending on the client requirements at the location of each box. Master Modules and Client Modules are connected to each other by way of an ISO-K style vacuum flange and quick connector according to Technical. The Modules are bolted to a support frame to create a Distribution Box assembly. The scope is split between TCC1/2 contracts depending on the area.

SSC to be installed are listed below, these items make up the Type 2 Vacuum Pumping for 2 systems:
2 sets of Turbo Molecular Pumps, fittings, pipework, flanges, isolation valves, ballistic shields, gages

Distribution Module Layout

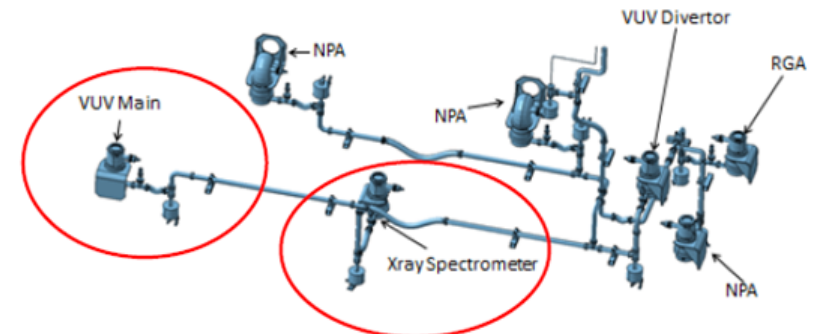
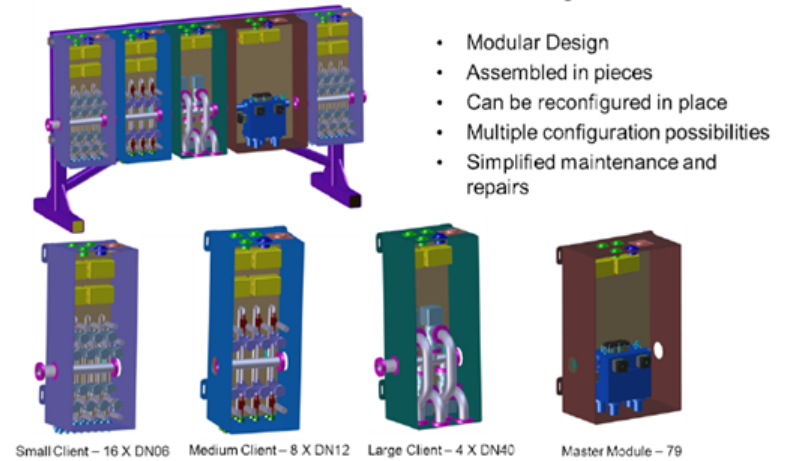

Vacuum system – Warm regeneration

The general layout comprises of Warm Regeneration Box which connects to the Warm Regeneration Line via a shaft to the clients in B1 level. The scope is split between TCC1/2 depending on the area.

Components to be installed are:

- Warm Regeneration Box
- Warm Regeneration Lines

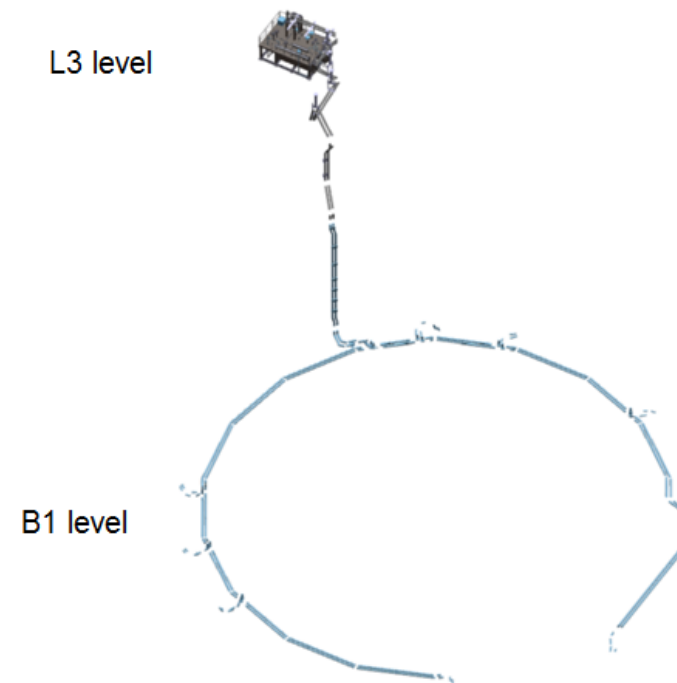

Tritium plant

- Tritium Building tanks (only 4 in scope)
- ANS Fume Hoods
- Limited scope for piping
- Gas supply compound System is PIC

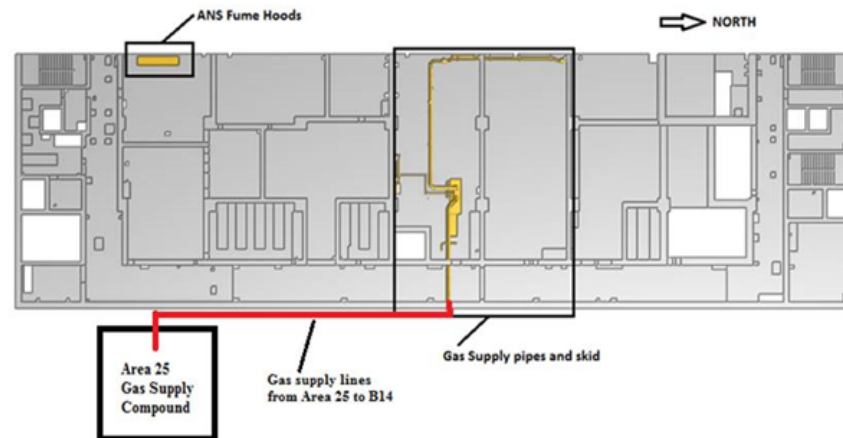
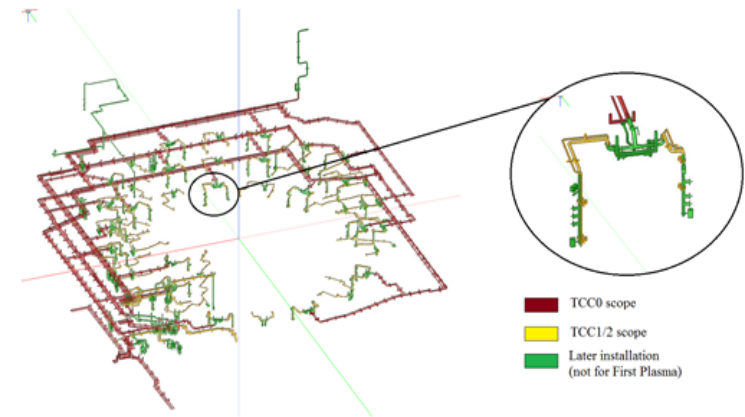
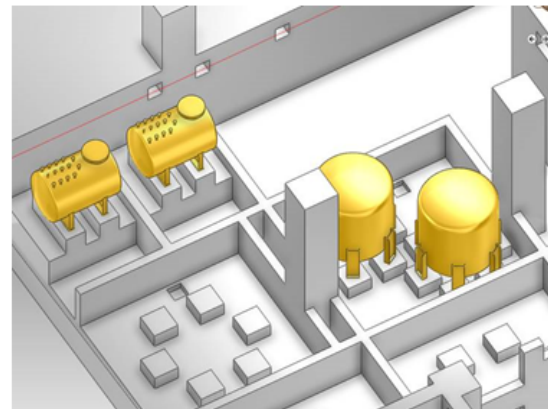

Ion Cyclotron Heating and CD system



Transmission lines

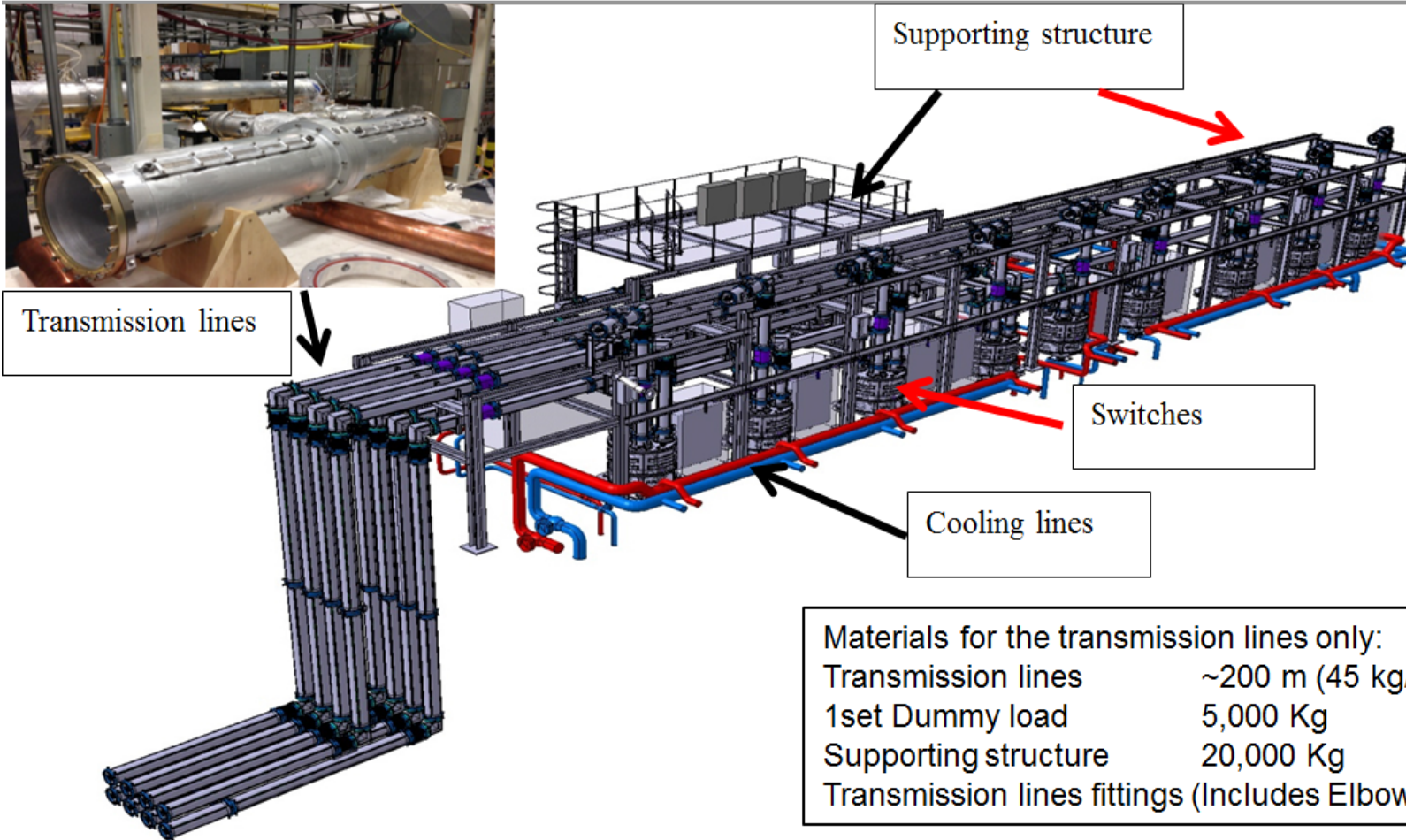

Materials for the transmission lines only:	
Transmission lines	~200 m (45 kg/m) DN 300
1set Dummy load	5,000 Kg
Supporting structure	20,000 Kg
Transmission lines fittings (Includes Elbow, Bellow, Tee etc.)	60pcs

Electron Cyclotron Heating and CD system

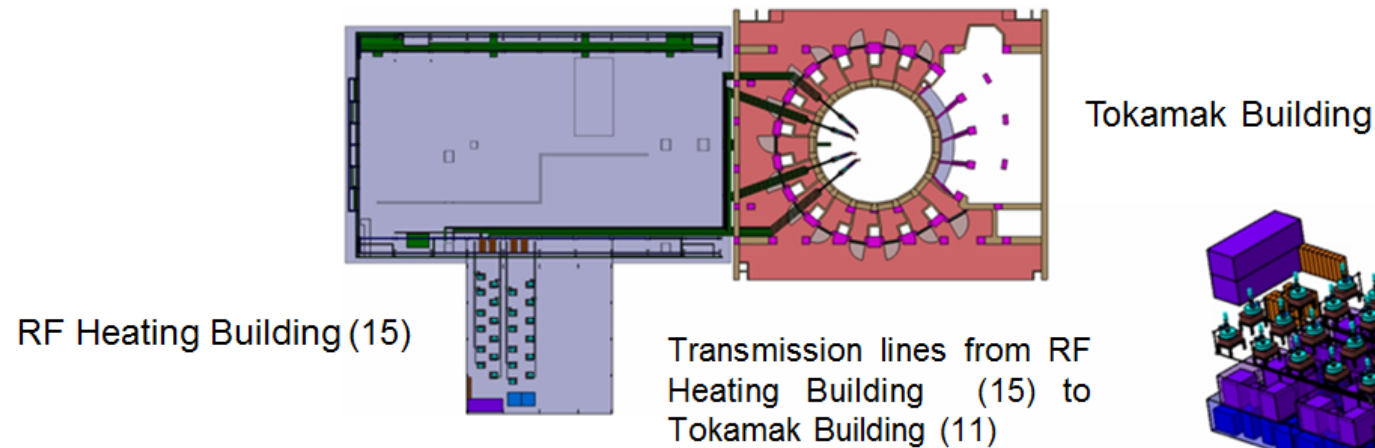

System is PIC

Materials for the transmission lines only:

Circular transmission line – 2.1 m section	1,400 m
Waveguide coupling	800 items
Pumping Tees	8 items
Bends	60 items

NOTE: Requires precise alignment $\pm 0.5\text{mm}$ over 4m distance between supports
Requires good practice with ultra high vacuum and high power microwaves.

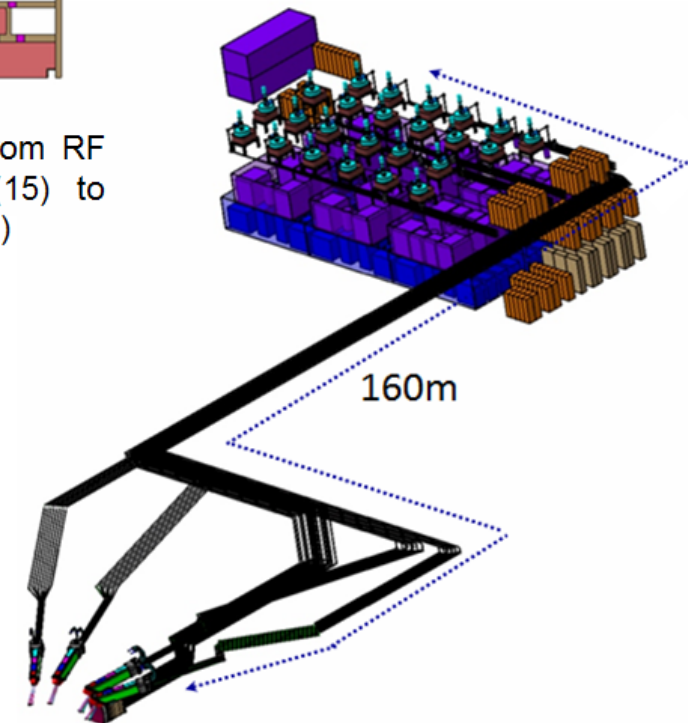

Electron Cyclotron Heating and CD system

Primary steps for waveguides installation:

- Metrology and installation of fiducials
- Installation of secondary steel structure
- Installation of waveguide support frames (~150)
- Pre-alignment of supports
- Installation of waveguides
- Installation of cooling lines (~2,000 connections)
- Alignment and vacuum tests

Installation of Gyrotron Ancillaries in RF Building (15):

- Gyrotron Support structures (8 Al frames 1.5m by 1.5m base ~2m height)
- 8 Cooling manifold and feeds

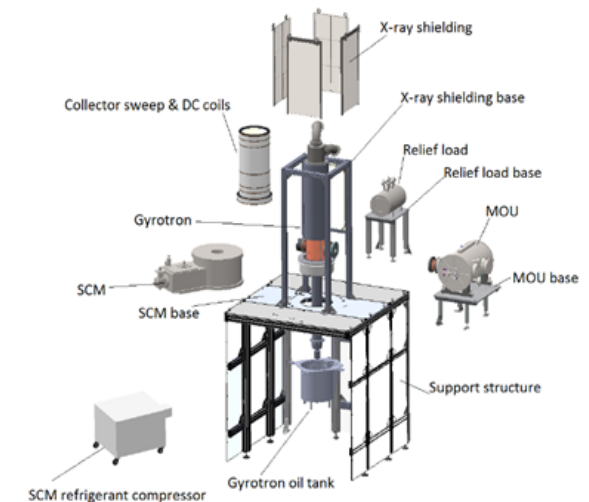

Diagnostic systems

In the scope of this contract, outside the Tokamak Machine boundary, several diagnostic systems will contain equipment along the port cells, galleries and in the diagnostic building. The systems include: vacuum connections, pipes, waveguides, fibre bundles, fitting and fixtures and through wall/through bldg. penetrations, diagnostic instruments, cables and cubicles.

Various diagnostic components, needed for second, third or DT operations have captive areas that needs to be installed under the scope of this contract (mainly supports, waveguides and ducts). It is foreseen to use temporary backfilling and sleeves/protection tubes for building penetrations.

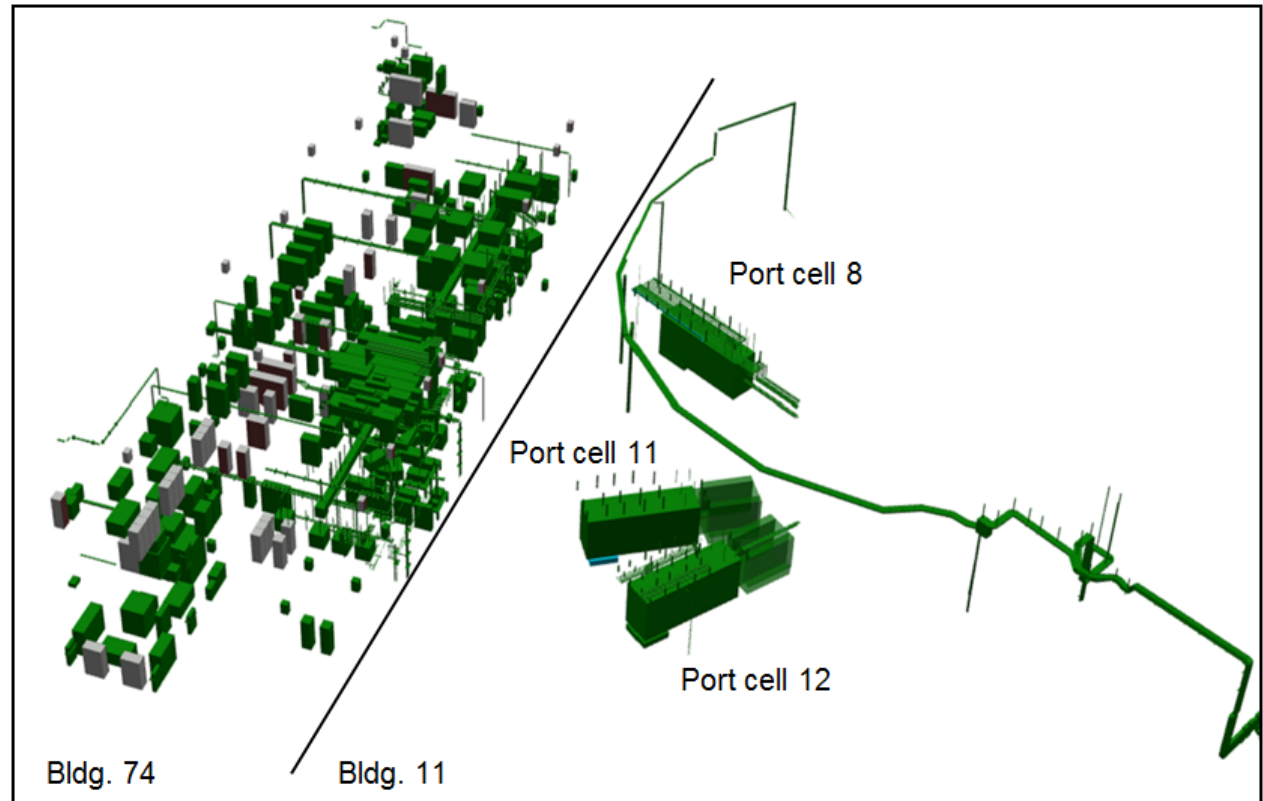

Various scope of installation Works

The scope is split between TCC1/2 contracts depending on the area.

Steel structure for platforms and walkways and supports for piping	
Item	Material
Steel structure for piping supports	Carbon steel and stainless steel
Steel structure for platforms	Structural Carbon steel

Procurement strategy

Overview of the procurement strategy related to the installation works		
Material	Quantity (% of total)	
Pipe Raw material	10%	
Spool prefabrication	60%	
Steel structure for platforms	100%	
Support prefabrication	60%	
Paint / coat	90%	
Anchors	50%	

I&C – Cabling – Cubicles

This section includes the IO preliminary indicative bills of quantity for the main item of tender in order to illustrate the scale of the contract and the required industrial capacity:

More detail on quantity and types will be indicated in the Technical document issued for the Call for Tender. This section includes the **full scope** for all the systems mentioned in the previous pages and for systems without mechanical installation scope. **The scope includes E&I installation with relevant cubicles and cables for systems already installed in some area (lower levels of Bldg. 11 and Bldgs. 13-15-74). The cables pulling scope is included in TCC1 contract only.**

Cables (Installation)

ITER Cables		
Estimated cable and tubing length (m)	Power cables (LV and MV)	207,025
	Instrumentation and control cables	1,233,505
	Pneumatic tubing	80,178
	Fiber optic cables	192,043

I&C – Cabling – Cubicles

Cable Tray (Installation of secondary cable trays mainly)

The following is the legend for the different cable tray types		
Estimated total cable tray length		8,8 km
Estimated type	Ladder with cover	54%
	Covered solid bottom	46 %
Conduit		50km

Example of tray type:

tray_type_code	description	width	depth	unit1
LD1000100	LADDER	1000	100	mm
LD100100	LADDER	100	100	mm
LD200100	LADDER	200	100	mm
LD300100	LADDER	300	100	mm
LD400100	LADDER	400	100	mm
LD500100	LADDER	500	100	mm
LD600100	LADDER	600	100	mm
LD800100	LADDER	800	100	mm
SBC100100	Covered Solid Bottom	100	100	mm
SBC200100	Covered Solid Bottom	200	100	mm
SBC300100	Covered Solid Bottom	300	100	mm
SBC400100	Covered Solid Bottom	400	100	mm
SBC500100	Covered Solid Bottom	500	100	mm
SBC600100	Covered Solid Bottom	600	100	mm
SBC600150	Covered Solid Bottom	600	150	mm
SBC800100	Covered Solid Bottom	800	100	mm

I&C – Cabling – Cubicles

CUBICLES (Installation only)

The scope is split between TCC1 and 2 contracts. The main scope is in TCC1

	Total
Estimated Floor and wall mounted Cubicle	1500

I&C – Cabling – Cubicles

I&C main Components (Installation only)

The scope included for the I&C preliminary Instruments and equipment list are:

- Conduits and fittings and their support system and all accessories (bolts, nuts, etc.) for interfacing the raceways with the Instruments or Instruments rack.
- Cable pulling and terminations, complete with all their accessories, from the instruments to the connection of the Junction Box or Control Cubicle.

The scope is split between TCC1 and 2 contracts

Estimated I&C Components	Total
Pressure Instruments and Switch	1,464
Temperature Instruments and Switch	3,050
Flow Instruments and Switch	488
Level Instruments and Switch	146
Valves Positioner, Position Switch, Open/Close Command	11,346