

# Technical Summary

## Mechanical and Piping Installation Works MCP Contract

### 1 Purpose

The purpose of this Call for Nomination is to establish a contract for all mechanical and piping pre manufacturing, assembly and installation works outside the Tokamak machine boundary of the ITER Project based in Saint-Paul Lez Durance, France.

The contract will include but not only engineering construction design, procurement of consumables items, piping insulation, pre manufacturing of supports and piping and steel platform procurement.

### 2 Background

ITER is based on the 'Tokamak' concept of magnetic confinement, in which the plasma is contained in a doughnut-shaped vacuum vessel. The fuel - a mixture of Deuterium and Tritium, two isotopes of Hydrogen - is heated to temperatures in excess of 150 million °C, forming a hot plasma. Strong magnetic fields are used to keep the plasma away from the walls; these are produced by superconducting coils surrounding the vessel, and by an electrical current driven through the plasma.

ITER is a large research facility made of a combination of large conventional industrial equipment such as the cooling water system and challenging new high tech components such as diagnostics, superconductive magnets, etc. To ensure the future operation of all ITER subsystems a large amount of power and control cables will have to be designed, identified, routed and installed.

For more information on ITER Project please visit our site [www.iter.org](http://www.iter.org).

### 3 Scope of Work

This contract includes all Mechanical and Piping Installation works outside the Tokamak vacuum boundary which are in IO scope for Phase I configuration, or which IO executes on behalf of Domestic Agencies (DA).

The scope of this contract includes various activities such as (refer to Annex for more details):

- Construction documentation,
- Pre-manufacturing and Installation of pipework spools including relative supports,

- Installation of pre-manufactured pipework spools including procured items from other DAs in the scope of IO,
- Installation of conventional equipment like pumps, compressors, heat exchangers, pressure vessels and valves,
- Installation of special components like cryopumps, cold boxes, gas valves boxes, pipe lines for cryo fluid, vacuum lines,
- Installation of specific systems requiring special cleanliness, techniques or accuracy (e.g. fuelling lines, transmission lines, waveguides, vacuum lines),
- Procurement, pre-manufacturing and installation of steel platforms and structures fixed to the buildings for man access or for supporting components or pipes when procurement or installation is in the scope of IO,
- Installation of the instrumentation which will constitute the process boundary (e.g. thermowells, in line instrumentation like flowmeters or others),
- Installation Tests (e.g. NDT, pressure test, leak tests and vacuum tests, calibration),
- Finishing works (e.g. internal cleaning, touch-up paint, thermal insulation, cladding, labelling and tagging),
- Start-Up and Pre-commissioning Activities,
- Assistance during commissioning activities performed by the IO or DA Operator of systems,
- The Contractor shall issue all the necessary documentation required to undertake and to follow-up installation activities and to record all activities (as built dossier),

NOTE: For some very specific operation (e.g. superconducting joints, optical alignments) the IO Mechanical & Piping Contractor (MCP) will have to interface with the companies awarded for the specific operations. The interfacing will be managed by IO supported by the Construction Manager as Agent (CMA).

The Contractor shall execute works according to instructions, with pricing based upon tendered unit rates for each type of work.

The Contractor shall have an ITER approved QA Program or an ISO 9001 accredited quality system in accordance with all the European standards, Construction and Design rules and French laws and decrees.

All above mentioned works shall be performed by the Contractor on the ITER site at Saint Paul-lez-Durance in France. The Contractor shall provide all necessary documentation, means and tooling or temporary works if required to properly manage and perform the different stages of work.

### 3.1 Option: LN2 plant in cryo buildings

As an option the Contractor shall install the LN2 plant in cryoplant buildings.

## 4 Interfaces with Other Companies

The overall set of contracts to be placed for construction activities are shown in the following figure. A summary of the main interfacing contracts is included in the following sections.

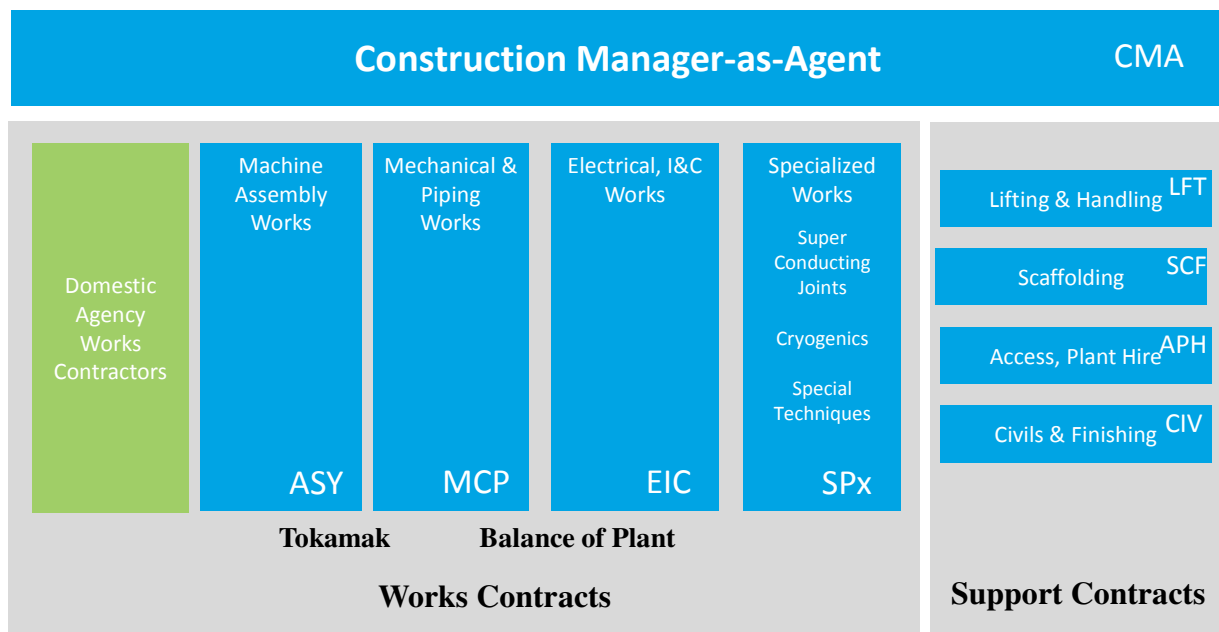

### 4.1 IO Construction Management-as-Agent Contractor

The IO placed the contract for Construction Management-as-Agent (CMA) services. The CMA Contractor shall be responsible for:

- Project Management,
- Works Preparation,
- Site coordination,
- Material management,
- Work supervision, quality control, record keeping,
- Management of Completion Activities,

The CMA interfaces with the Contractor at different steps of the works (preparation, quotation and scheduling, performance and acceptance).

The CMA acts as the Engineer for this Works Contract under the FIDIC “Red Book”.

## **4.2 Cable Supply, Electrical and I&C Installation Works Contractor**

The IO is currently tendering for Cable Supply, Electrical and I&C Installation Works (EIC) Contractor. The EIC Contractor shall be responsible for design, cable harness pre-manufacturing, cable pulling, termination, bus-bars, switch equipment, electrical equipment installation and hook-ups.

The scope of this contract includes installation of:

- DC Busbar and Switching Network
- Power, Instrumentation and Control Cables
- Cable Trays and Conduits
- Low Voltage Panels and Junction Boxes
- Instrumentation and Control Cabinets
- Cabling Infrastructure for Control System
- Instrumentation and related Equipment
- Access Control and Security Equipment

## **4.3 Tokamak Machine Assembly**

The IO intends to launch the procurement tendering process the Tokamak Machine Assembly contract. The Contractor shall be responsible for all mechanical and electrical assembly and installation works up to the nearest physical interface at or beyond the outermost vacuum boundary of the Tokamak, including all in-vacuum cabling – with the exception of specialised works (such as super-conducting magnet joints) and installation of the cryostat (INDA scope).

## **4.4 Lifting & Handling, Scaffolding and Access**

IO intends to tender a contract for the unloading, inspection, storage, preservation and delivery on-site of Material to the construction site (on-site logistics).

In addition, the IO will put in place an On-site Lifting and Handling Contract for the lifting and handling of Material within the ITER Site. These contracts shall be used by the works contractors. Similarly, IO will put in place a contract for the provision of scaffolding and related access means for use by all works contractors.

## 5 Conflict of Interest

There is a strict conflict of interest situation between the CMA contract and Works contracts. That means that no member or subcontractor of the CMA contract can participate to any works activities.

Awarded consortium members (or part of any joint liable type of legal grouping arrangement) shall not participate in the following contracts as consortium member:

- Cable Supply, Electrical and I&C Installation Works Contract,
- Machine Assembly Contract.

However, the companies involved in one works contract as consortium members, are authorized to participate to the above mentioned contracts as sub-contractors.

This limitation does not apply to contracts already placed by the IO by the time of the signature of this contract, or to contracts placed or to be placed by the Domestic Agencies unless specifically mentioned before signature of the said contracts.

The same principles as above apply to Parent Companies or subsidiaries.

By "Parent Companies" it is meant a firm that owns or controls other firms (called subsidiaries) which are legal entities in their own right. IO will consider as a subsidiary a company controlled by another (the parent) through the ownership of greater than 50 percent of its voting stock. This basically represents 50% + 1 vote.

Voting Stocks (or voting shares) are the ordinary shares the ownership of which gives an entity the right to vote in the issuing firm's annual general meeting. The ultimate and exclusive right conferred by a lawful claim or title, and subject to certain restrictions to enjoy, occupy, possess, rent, sell, use, give away, or even destroy an item of property.

Parent Companies can be a holding. In that particular case, and in order to simplify the implementation of this principle for holdings which definition can vary with the legal system, the IO will retain the same definition as for Parent Companies (> 50% of voting shares).

## 6 Timetable

The tentative timetable is as follows:

Call for Nomination	July 2016
Pre-qualification	August 2016
Deadline for receipt of pre-qualification:	October 2016
Issue of the Call for Tender	November 2016
Tenderers' meeting	December 2016
Tender Submission Date	February 2017
Award of the Contract	May 2017
Contract Signature	July 2017

The estimated duration of the contract is 9 years.

## 7 Experience

The Contractor and its personnel shall have adequate experience in piping and mechanical installation works. This includes but it is not comprehensive:

- Pipes and supports,
- Vacuum systems installation,
- Installation of sensitive components within a very tight tolerance,
- All kind of in-line components,
- All kind of mechanical equipment for plants,
- All kind of tanks.

The Contractor shall demonstrate to have adequate experience in installation of equipment in compliance with:

- French Order dated 7 February 2012,
- ASME III or RCC-M or equivalent nuclear code,
- ASME B31.3,
- ESPN regulation,
- French Decree n°99-1046 of December 13 1999 or European Directive 97/23/EC and in the Directive 2006/42/EC relative to pressure equipment.

In addition, it is required to have experience in:

- International projects, i.e. customer(s) and/or supplier(s) from different countries, with all documentation being delivered in English,
- Construction sites with high occupational safety standards.

For specific domains, the technical experience of the sub-contractors will be considered at the pre-qualification stage.

## **8 Candidature**

Participation is open to all legal persons participating either individually or in a grouping (consortium) which is established in an ITER Member State. A legal person cannot participate individually or as a consortium partner in more than one application or tender of the same contract. A consortium may be a permanent, legally-established grouping or a grouping, which has been constituted informally for a specific tender procedure. All members of a consortium (i.e. the leader and all other members) are jointly and severally liable to the ITER Organization.

The consortium grouping shall be presented at the Pre-Qualification stage. The Candidate's composition cannot be modified without the approval of the ITER Organization after the Pre-Qualification.

Legal entities belonging to the same legal group are allowed to participate separately if they are able to demonstrate independent technical and financial capacities. Candidates (individual or consortium) must comply with the selection criteria. The IO reserves the right to disregard duplicated reference projects and may exclude such legal entities from the Pre-Qualification procedure.

## **9 Nuclear liability**

The ITER Organization is the nuclear operator of the ITER nuclear fusion facility (INB 174) under French nuclear law. However, unlike other nuclear operators of nuclear fission installations in France, nuclear fusion installations are not covered by the Paris Convention on nuclear third party liability for the time being. Pending negotiations with the Contracting parties to the Paris Convention, the special nuclear liability regime (i.e. limited strict liability of the nuclear operator) implemented by the Paris Convention does not apply.

Therefore, the ITER Council, by a decision of 2009 endorsed that until a solution is found, the ITER Organization may assume this responsibility by providing a declaration and waiver of indemnity regarding nuclear liability to indemnify suppliers of the IO and their subcontractors in case they are held liable, based on the principles of the Paris convention, this in the understanding that if no regulatory solutions could be found before nuclear operations of the ITER facility started, a proper mechanism would be

established by the ITER Members in accordance with Article 15 of the ITER Agreement.

This declaration and waiver of indemnity regarding nuclear liability shall be included in the contract signed by the Contractor and the IO.

## **10 CEAR Insurance**

The ITER Organization and Fusion for Energy, the European Domestic Agency in charge of providing buildings to the ITER Organization, have taken out an insurance policy to cover:

- the risk of physical loss or material damage to the Project arising from whatsoever cause except if excluded,
- as well as to cover all sums which the Insured shall become legally liable to pay in respect of or arising from accidental bodily injury to or illness of third parties and accidental loss or damage or destruction to property belonging to third parties occurring during the construction/erection period on the construction site and arising from or in connection with the Insured Project unless excluded (CEAR Insurance Policy)

Contractors, Subcontractors of any tier and suppliers and/or consultants (in respect of their site activities) are also covered by this insurance policy and as such are only liable for the deductible, the exclusions or above the limit of coverage mentioned in the insurance policy in accordance with the insurance certificate that will be provided to you during the next phase of the tender process.

This insurance policy carries a global aggregate coverage limit of Euro 1,000,000,000 (one billion Euro).

The ITER Organization and Fusion for Energy will cover their own buildings used by the contractors to perform their duty on Site, excluding the content being the contractor's property.

The CEAR insurance policy subscribed by the ITER Organization and Fusion for Energy shall not affect the contractor's liabilities or obligations.

## **11 Subcontracting Rules**

Sub-contracting is allowed, but it is limited to two levels and its cumulated volume is limited to 50% of the total contract value. As mentioned in the Article 7, the experience of sub-contractors will be considered at the pre-qualification stage for specific domains.





## **Annex**

***Mechanical and Piping Installation Works Contract  
Overview of Scope of Work***

---

# ***Mechanical and Piping Installation Works Contract***

## ***Overview of Scope of Work***

## List of Main Systems in the Scope of Work of MCP Contract

---

- *Fuelling and wall conditioning system*
- *Cooling Water system*
- *Vacuum system*
- *Tritium Plant including Detritiation system*
- *Ion Cyclotron Heating and current drive system*
- *Electron Cyclotron Heating and current drive system*
- *Neutral Beam heating and current drive system*
- *Diagnostics system*
- *Test Blanket Modules system*
- *Steel structure platforms for man access & support of equipment*
- *Liquid and gas distribution system*
- *Radioactive waste treatment and storage system*

## Fuelling network - Nuclear Building

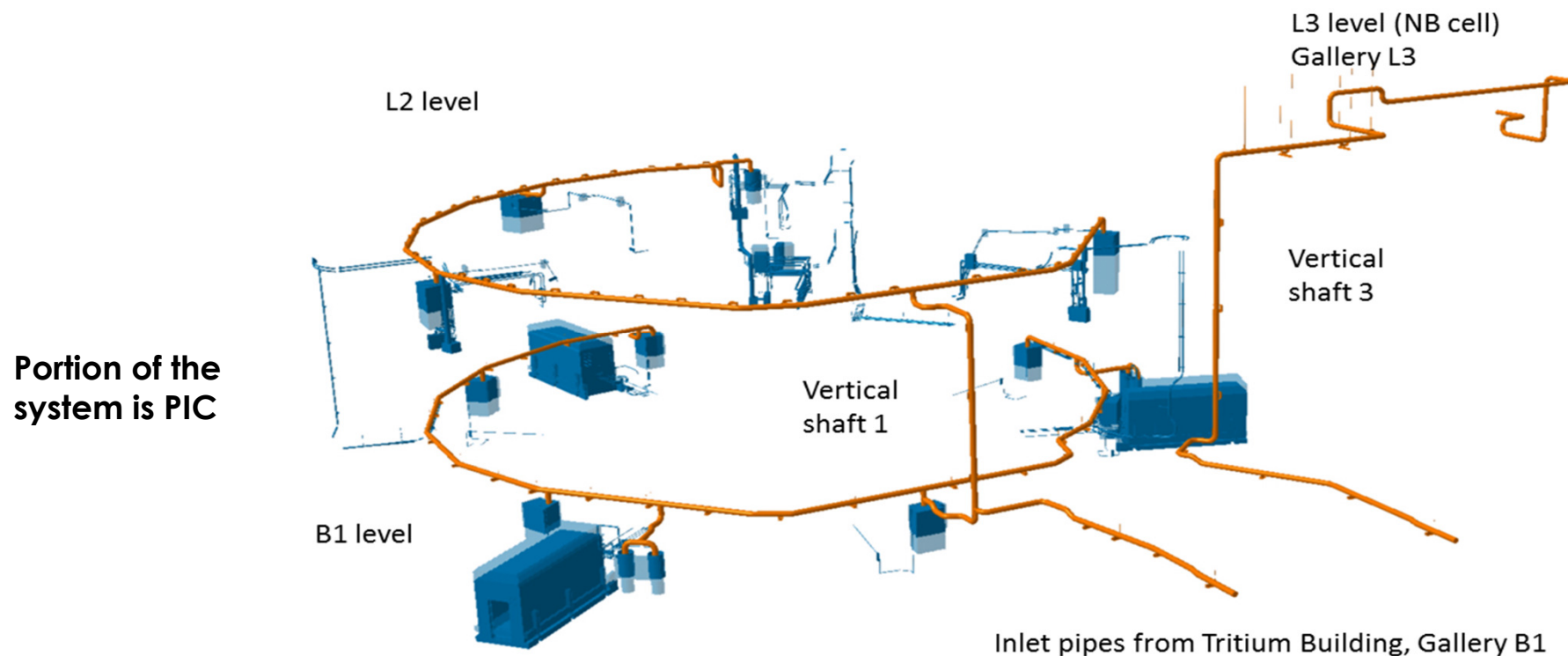

**Estimated 1,300 m of piping (multi pipe concept) and 12 gas boxes to install**

## Fueling Network – piping & equipment

Gas Distribution System (GDS) Manifold – Multicore Gas Line				
System	Material	No. of process pipes within Guard pipe	~ No of elements/spools	Tentative Size (mm)
GDS	Process pipes: Austenitic Stainless steel [316 L] Outer jacket: Austenitic Stainless steel [316 L]	6	76	Process pipes: from DN 15 Outer jacket: DN 250

Subsystem	Description	Qty.	(L x W x H) (m)	Weight (tons)
GIS GVBs	Gas Valve Box	10	1.35 x 1.3 x 1.32	2
PIS GVBs	Gas Valve Box	2		5

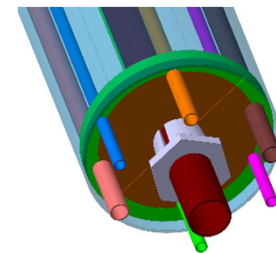

# Tokamak Cooling Water system (TCWS) – Nuclear Building

TCWS Systems are PIC  
and some component are  
ESPN classified

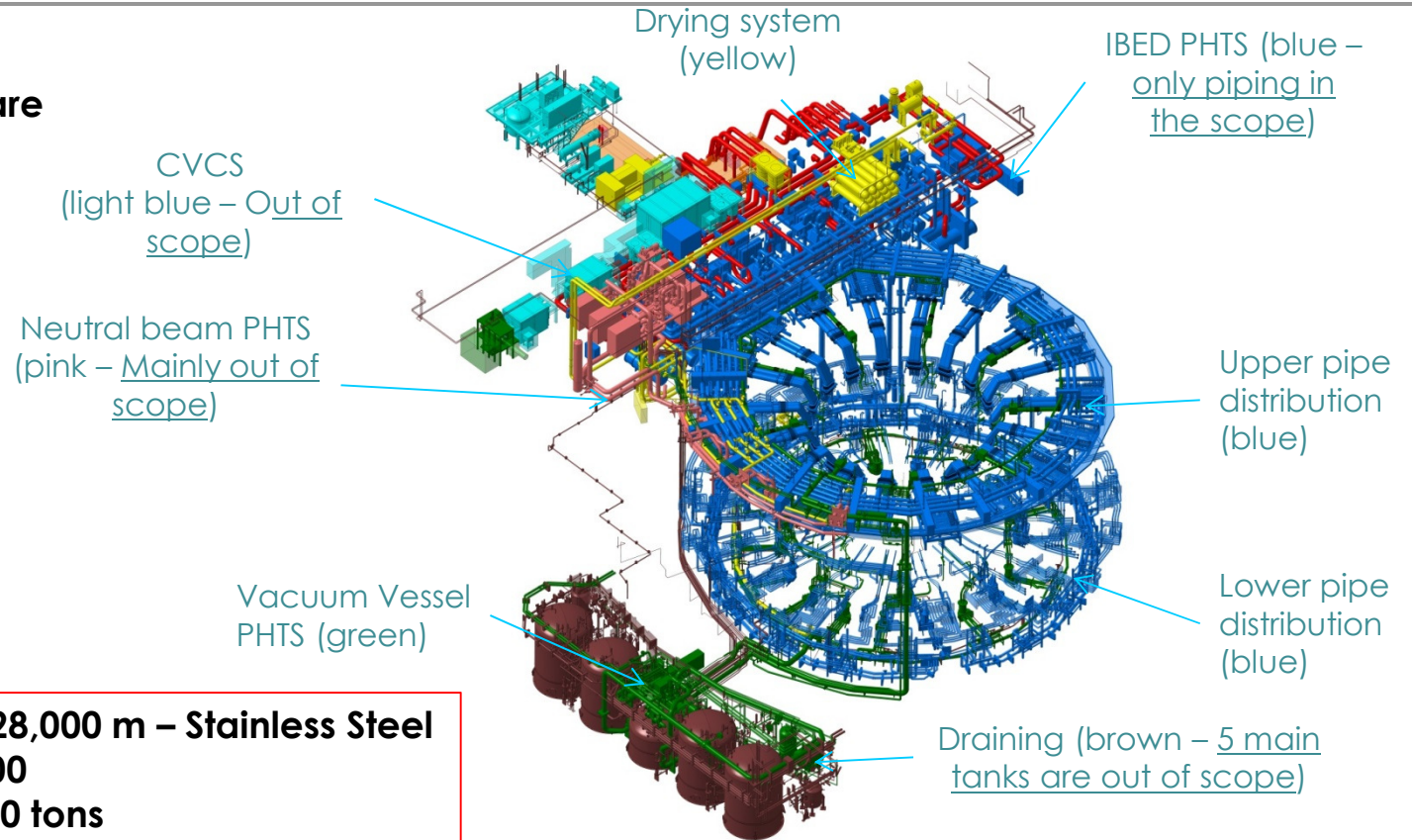

**Approx. pipe length 28,000 m – Stainless Steel**  
**Number of valves 3000**  
**Weight of supports 200 tons**

# TCWS Equipment

Subsystem	Qty.	(L x W x H) (m)	Weight (tons)
<b>TCWS-VV-PHTS</b>			
Primary pump	1	5 x 2 x 2	16.8
Primary Heat Exchanger	1	6.5 x 0.8 x 2	6.3
Pressurizer	1	6 x 6 (dia x h)	9
Baking heater	1	3.1 x 2 x 2.8	3.5
Chemical Additive Skid	1	0.55 x 0.55	1.40
Chemical Injection pump	1	1.2 x 1.2 x 1.7	1.4
Filter booster pump	1	2 x 1 x 0.8	1.2
pressure relief tank	1	2.3 x 3.5 x 2.9	6
Decay HX	1	2 x 0.5 x 1.3	0.75
Volume Control Heat Exchanger (Letdown Cooler)	1	3.7 x 0.8 x 1.8	1.9
Decay Heat Pump	1	3650 x 1560	3.2
Volume Control Charging Pumps (Vertical Pumps)	1	0.6 x 0.6 x 1.5	1.5
Charging Pump	1	4 x 1	6.00
Filter	1	0.7 x 0.5 x 2.5	3.28
Filter	1	0.7 x 0.5 x 2.5	3.28
Seal Injection filter	1	0.3 x 1.2 (dia x h)	0.80

Subsystem	Qty.	(L x W x H) (m)	Weight (tons)
<b>TCWS-DYS</b>			
Cyclone separator	1	2 x 1.5 x 4.2	5
Cyclone separator	1	0.9 x 6.5 x 1.5	6.3
Drying Compressor	1	3 x 2.3 x 1.5	4.5
Charging Compressor	1	9 x 3.3 x 3	36.7
Heater	1	4.6 x 0.45 x 1.2	2.6
Demister	1	2.7 x 1.4 x 2.7	4.1
Filter Including local shielding	2	1.2 x 1.2 x 3.3	10.00
CCWS Condenser	1	2 x 1 x 1.5	6.8
CHWS Condenser	1	1 x 0.6	8.40
N2 Storage tank	1	6.4 x 4 x 4	74.00
Economizer	1	2.8 x 1.3 x 2.6	5.5
Buffer Tank #1	1		3.00
Buffer Tank #2	1		1.00
Buffer Tank #3	1		1.00
Buffer Tank #4	1		1.50

Subsystem	Qty.	(L x W x H) (m)	Weight (tons)
<b>TCWS-DRS</b>			
Waste collector tank	1	3 x 3 x 8.2 (dia x h)	14.7
Refilling Pump (vertical)	1	0.7 x 4 (dia x h)	0.58
Sump Tank Pump (vertical pump)	1	0.6 x 3.61 (dia x h)	0.33
Safety Drain Tank Transfer Pump (Vertical Pump)	1	0.0.6 x 4 (dia x h)	0.58
NBI PHTS drain and refilling transfer pump (vertical pump)	1	0.0.6 x 4 (dia x h)	0.58

# CCWS – CHWS – HRS – Partially Nuclear Building

## Component Cooling Water System (CCWS) Chilled Water System (CHWS) Heat Rejection System (HRS)

Function: transfer heat from Tokamak and auxiliary systems to Heat Rejection System (HRS).

- Location: throughout the site;
- Scope of work is limited to the installation inside of the Buildings.

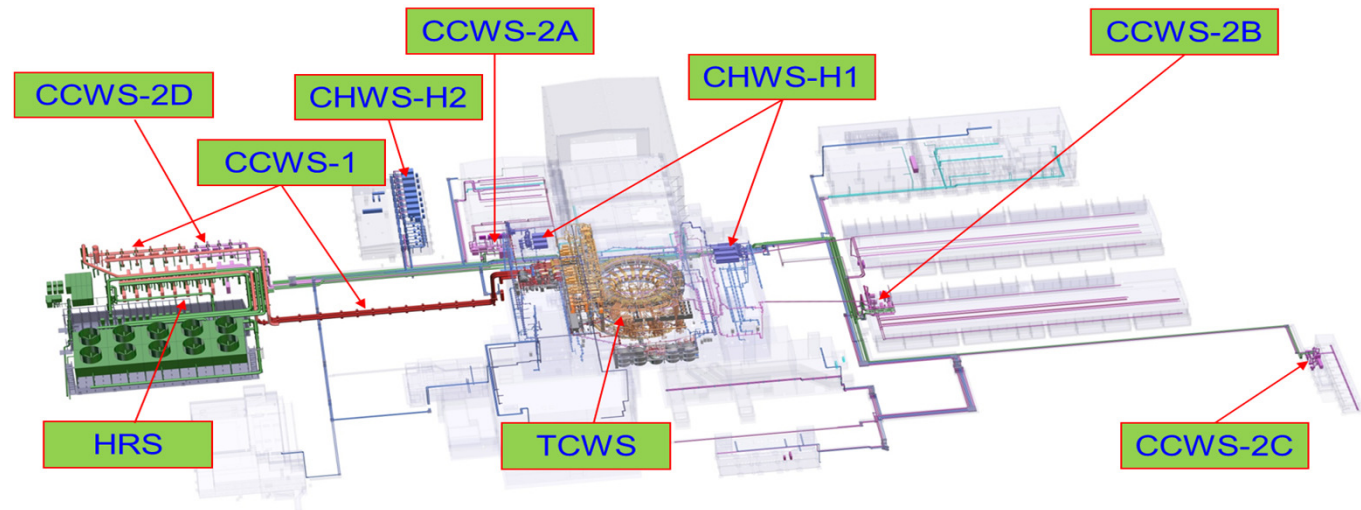

**Total length about: 19,000 m Stainless Steel (650 tons of pipe work) in scope  
6,000 m Carbon Steel (100 tons of pipe work) in scope**



## Cooling Water Equipment

Subsystem	Description	Qty.	(L x W x H) (m)	Weight (tons)	Subsystem	Description	Qty.	(L x W x H) (m)	Weight (tons)
<b>CCWS-2A</b>					<b>CCWS-2D</b>				
<b>Plate Heat Exchangers</b>	Stainless Steel Plate Heat Exchanger	1	7.0 x 2.0 x 4.5	30	<b>Plate Heat Exchangers</b>	Stainless Steel Plate Heat Exchanger	3	6 x 2 x 4.5	40
<b>Pressurisation Units</b>	Vertical Nitrogen gas Pressuriser with access ladder & platform	1	1.1 ø x 4	2.5	<b>Pressurisation Units</b>	Vertical Nitrogen gas Pressuriser with access ladder & platform	1	1.5 ø x 2.0	5
<b>CCWS-2A Pumps</b>	Centrifugal Pumps	3	3.0 x 1.5 x 1.5	6.3	<b>CCWS-2D Pumps</b>	Centrifugal Pumps	4	5.0 x 2.5 x 3.0	15
<b>Polishing Unit</b>		1+1			<b>Caustic addition system</b>		1	2.3 x 2.1 x 1.9	2
Subsystem	Description	Qty.	(L x W x H) (m)	Weight (tons)	Subsystem	Description	Qty.	(L x W x H) (m)	Weight (tons)
<b>CCWS-2B</b>					<b>CCWS-2C</b>				
<b>Plate Heat Exchangers</b>	Stainless Steel Plate Heat Exchanger	2	4.0 x 1.5 x 3.2	10	<b>Plate Heat Exchangers</b>	Stainless Steel Plate Heat Exchanger	1	4.0 x 2.0 x 2.5	10
<b>Pressurisation Units</b>	Vertical Nitrogen gas Pressuriser with access ladder & platform	1	1.2 ø x 4.0	2.5	<b>Pressurisation Units</b>	Vertical Nitrogen gas Pressuriser with access ladder & platform	1	1.5 ø x 4.0	10
<b>CCWS-2B Pumps</b>	Centrifugal Pumps	3	4.0 x 2.0 x 1.5	7	<b>CCWS-2C Pumps</b>	Centrifugal Pumps	2	3.0 x 1.0 x 1.5	10
<b>Polishing Unit</b>		1+1			<b>Polishing Unit</b>		1+1		

## Cooling Water Equipment

Subsystem	Description	Qty.	(L x W x H) (m)	Weight (tons)	Subsystem	Description	Qty.	(L x W x H) (m)	Weight (tons)
<b>CHWS-H1-Train A</b>					<b>CCWS-1</b>				
<b>Water cooled chillers</b>	Water Cooled Centrifugal Chiller	4	4.5 x 1.5	5.0	<b>Plate Heat Exchangers</b>	Stainless Steel Plate Heat Exchanger	14	6.0 x 2.0 x 4.5	40
<b>Chilled water pumps</b>	Inline Centrifugal Pumps	4	2.5 x 1.25	2.0	<b>Pressurisation Units</b>	Vertical Nitrogen gas Pressurisers with access ladders & platforms	2	2.8 $\phi$ x 5.0	35
<b>Condenser water pumps</b>	Inline Centrifugal Pumps	4	2.5 x 1.25	2.5					
<b>Dry coolers</b>	Air Cooled Dry Cooler	4	16.0 x 3.0	2.5	<b>CCWS-1 Pumps</b>	Centrifugal Pumps	6	5.0 x 2.5 x 3.0	15
<b>Pressurisation Unit</b>	Vertical Nitrogen gas Pressuriser with access ladder & platform	2	1.5 x 1.5	0.8					

Subsystem	Description	Qty.	(L x W x H) (m)	Weight (tons)
<b>CHWS-H1-Train B</b>				
<b>Water cooled chillers</b>	Water Cooled Centrifugal Chiller	4	4.5 x 1.5	5.0
<b>Chilled water pumps</b>	Inline Centrifugal Pumps	4	2.5 x 1.25	2.0
<b>Condenser water pumps</b>	Inline Centrifugal Pumps	4	2.5 x 1.25	2.5
<b>Dry coolers</b>	Air Cooled Dry Cooler	4	16.0 x 3.0	2.5
<b>Pressurisation Unit</b>	Vertical Nitrogen gas Pressuriser with access ladder & platform	2	1.5 x 1.5	0.8

# Cooling Water Towers, Pumps and Heat Exchangers buildings 67/68/69

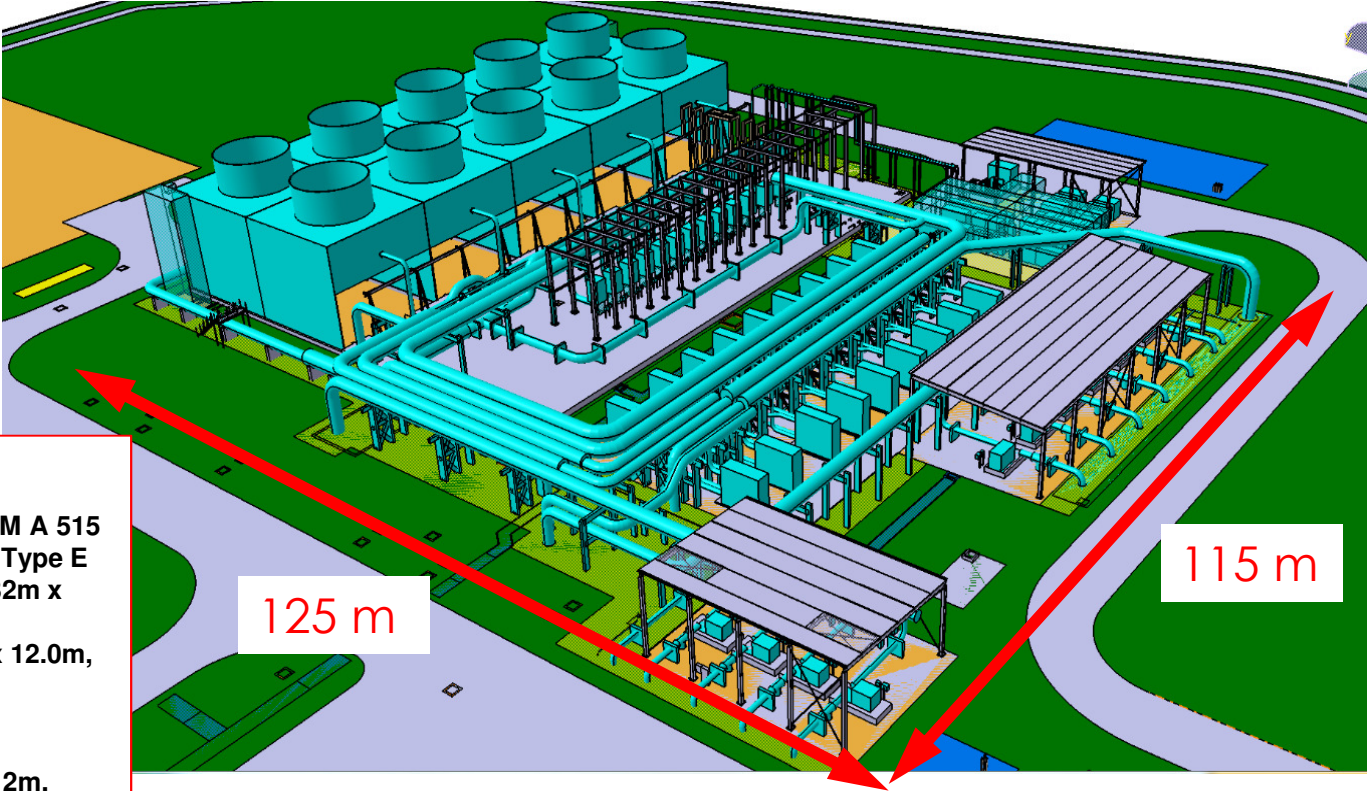

- 1,800 m of pipes above DN1000,
- 2,200 m of pipes DN25-DN750,
- ASTM A 672 Gr B60 CL-12 FROM ASTM A 515 GR 60 PLATES and ASTM A 53 Gr. B, Type E
- 10 Cooling Water Tower Cells 64m x 32m x 22m,
- 13 vertical circulation pumps 3.0m  $\varnothing$  x 12.0m,
- 17 heat exchangers,
- 10 circulation pumps,
- 3 pressurizer tanks,
- 3 Chemical dosing System 4m x 2m x 2m,
- 2 ozonation plant equipment 12m x 3m x 3m
- 10 set stoplog gate & screen 3.2m x 0.5m x 4m

## Vacuum system – Nuclear Buildings

About 10,000 m of stainless steel piping from DN25 to DN300  
Vacuum components:  
cryopumps, cold valve boxes,  
gas analyzer

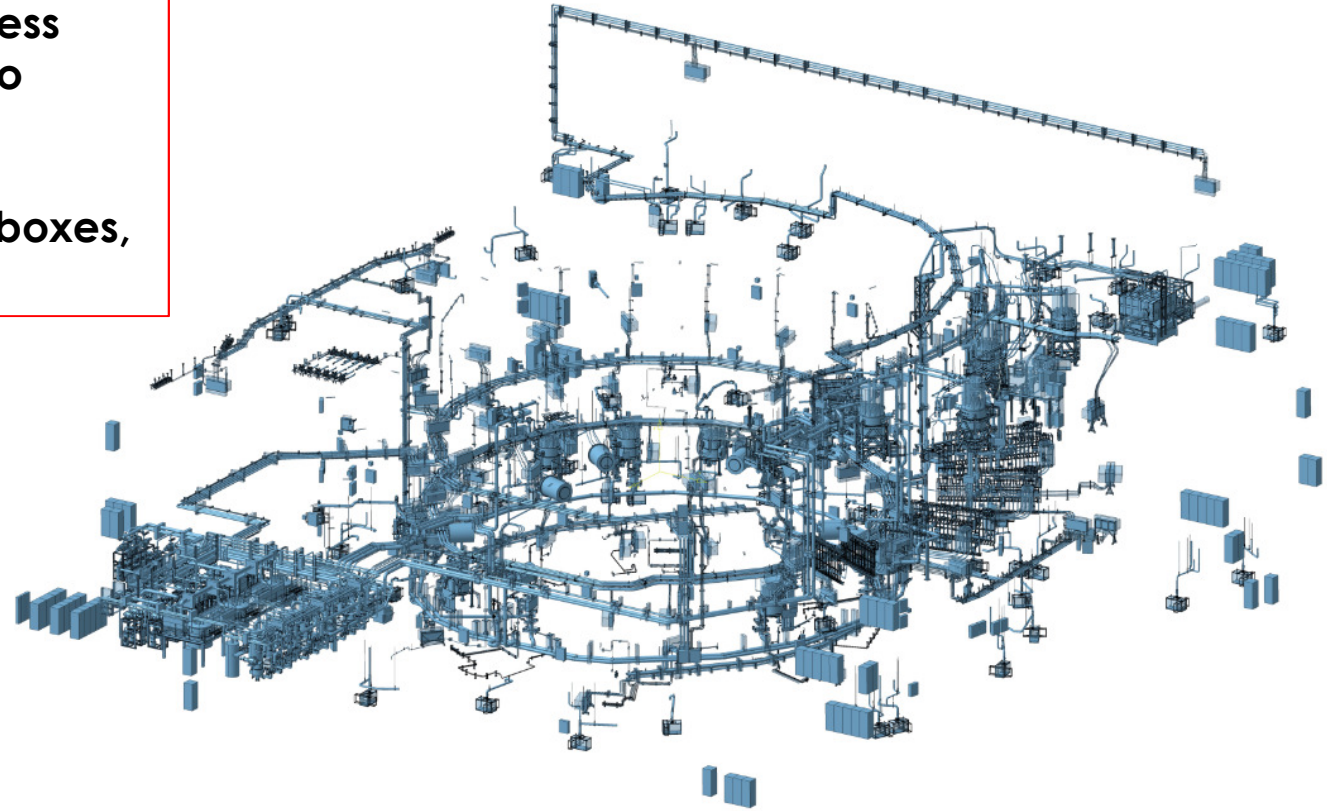

Portion of the system is PIC

# Tritium – Nuclear Building

Tritium Building (out of current scope)

System is PIC

Tokamak Building

Hot Cell Building (out of current scope)

**About 100 m of stainless steel piping is remaining in the scope of this contract**



# Ion Cyclotron Heating and CD system – Nuclear Building

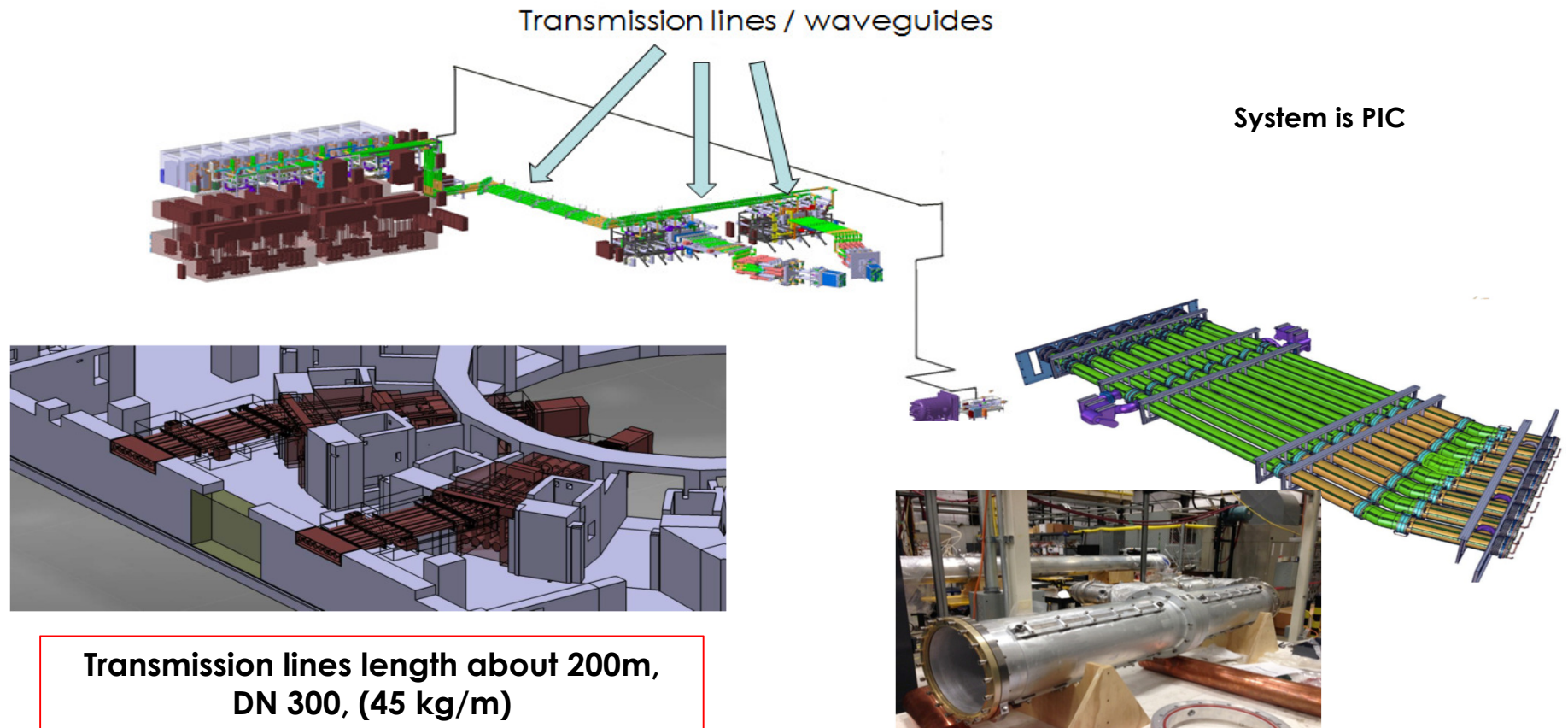

# Ion Cyclotron Heating and CD system – RF Heating Building

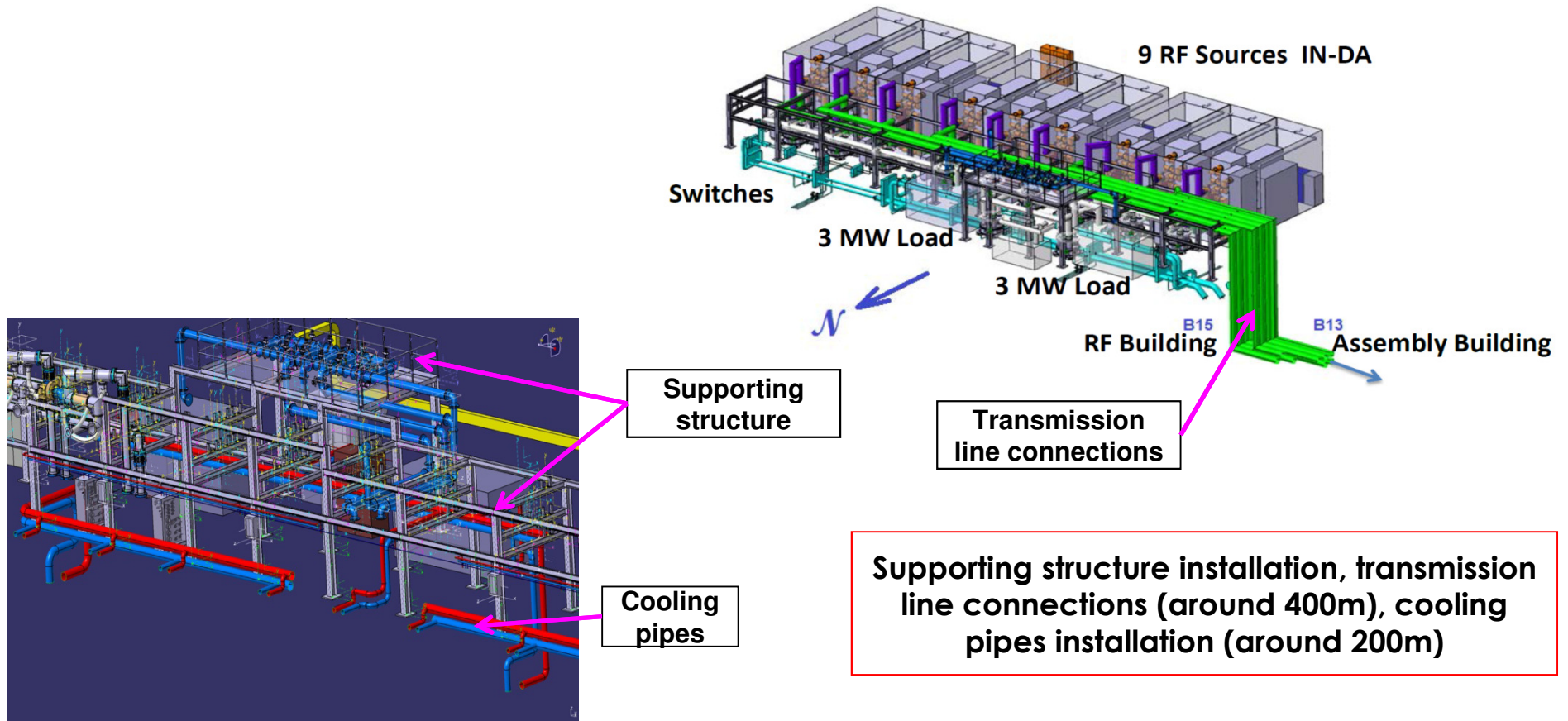

# Electron Cyclotron Heating and CD system – Nuclear building

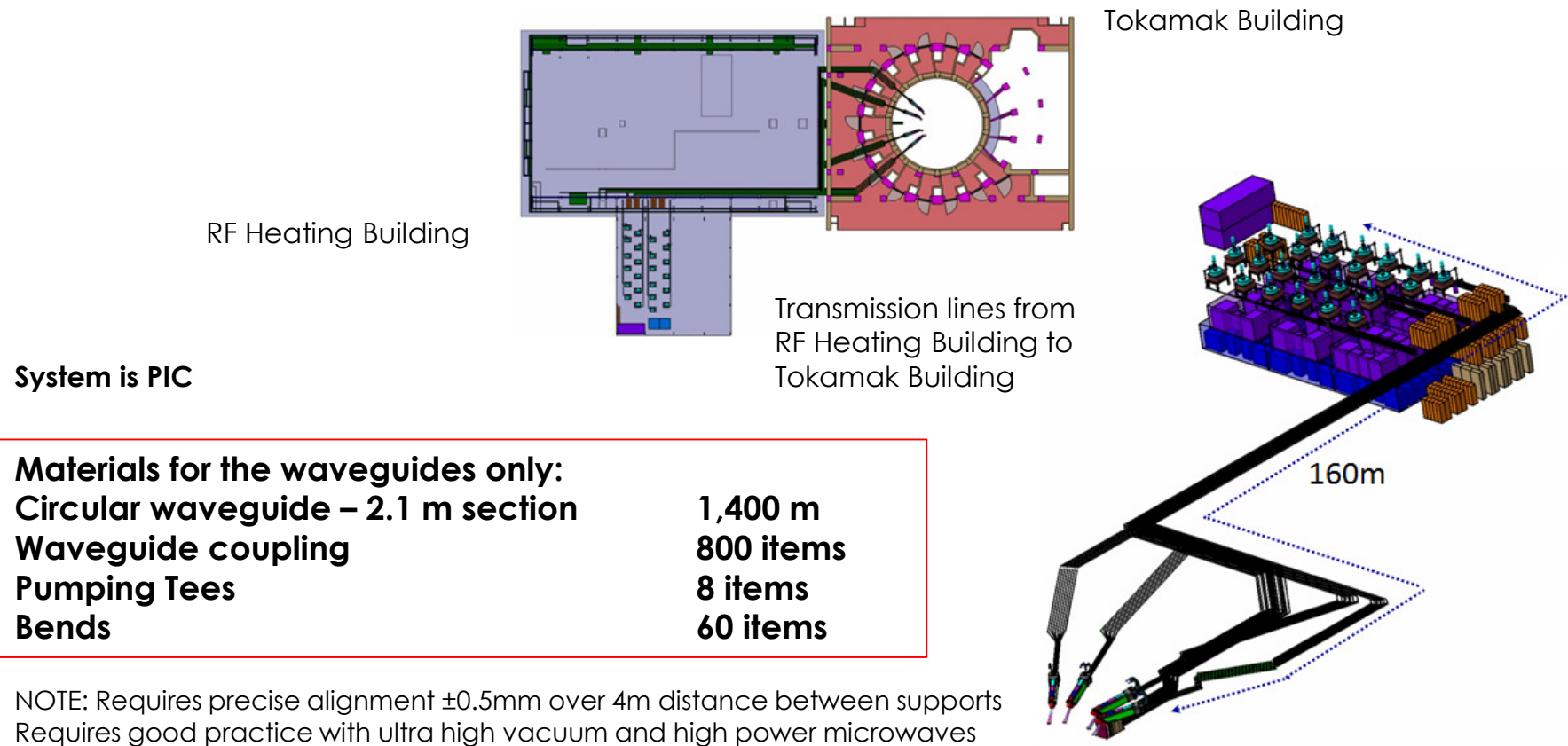



# Electron Cyclotron Heating and CD system – Nuclear Building

## Primary steps for waveguides installation:

- Metrology and installation of fiducials
- Installation of secondary steel structure
- Installation of waveguide support frames (~150)
- Pre-alignment of supports
- Installation of waveguides
- Installation of cooling lines (~2,000 connections)
- Alignment and vacuum tests

## Installation of Gyrotron Ancillaries in RF Building:

- Gyrotron Support structures (8 Al frames 1.5m by 1.5m base ~2m height)
- 8 Cooling manifold and feeds

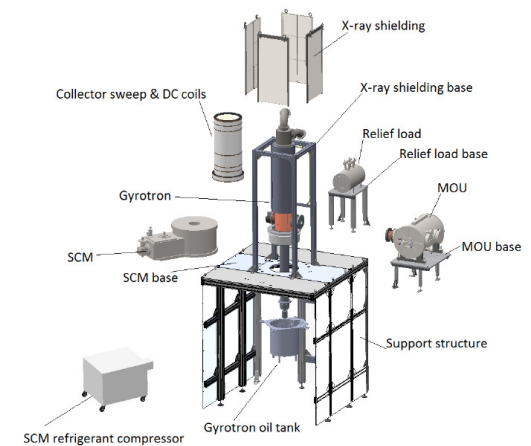

# Neutral Beam – Nuclear building

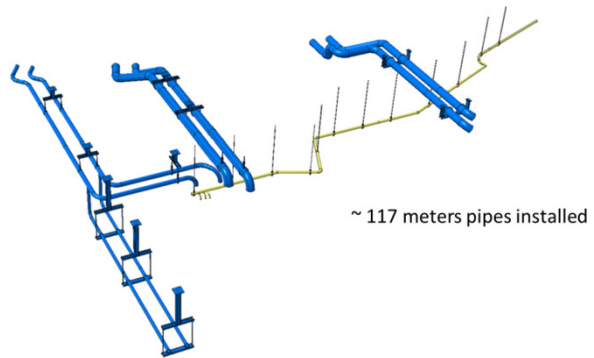

~ 117 meters pipes installed

Captive pipes only, length 117 m

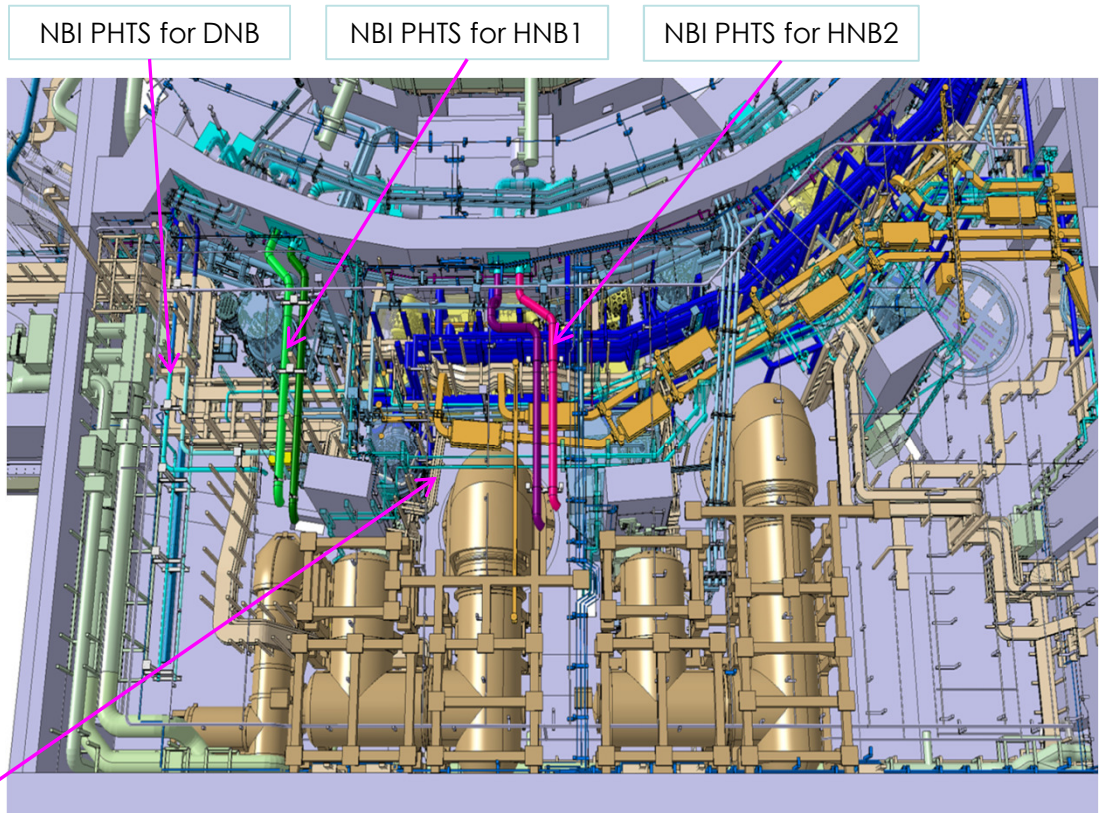

NBI PHTS for DNB

NBI PHTS for HNB1

NBI PHTS for HNB2

CCWS pipes

# Neutral Beam – Nuclear building

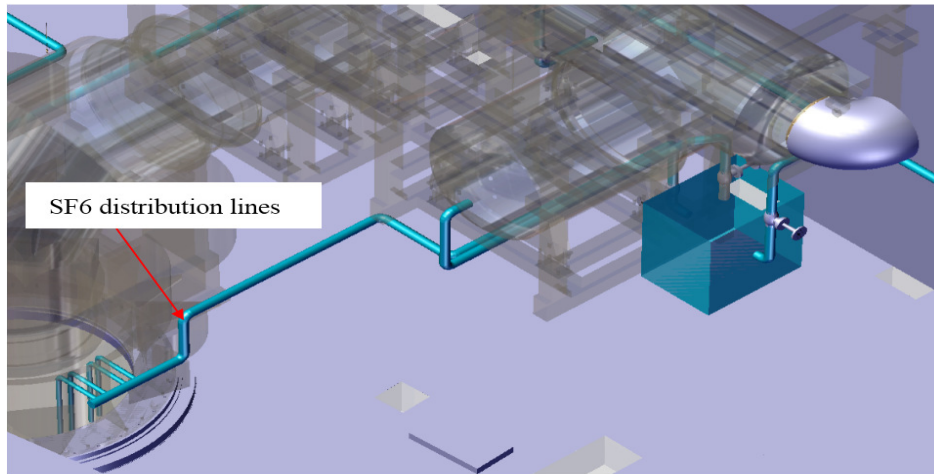

**SF6 system for HNB 2**  
**SF6 distribution system at HV Deck room**

**SF6 system for HNB 1**

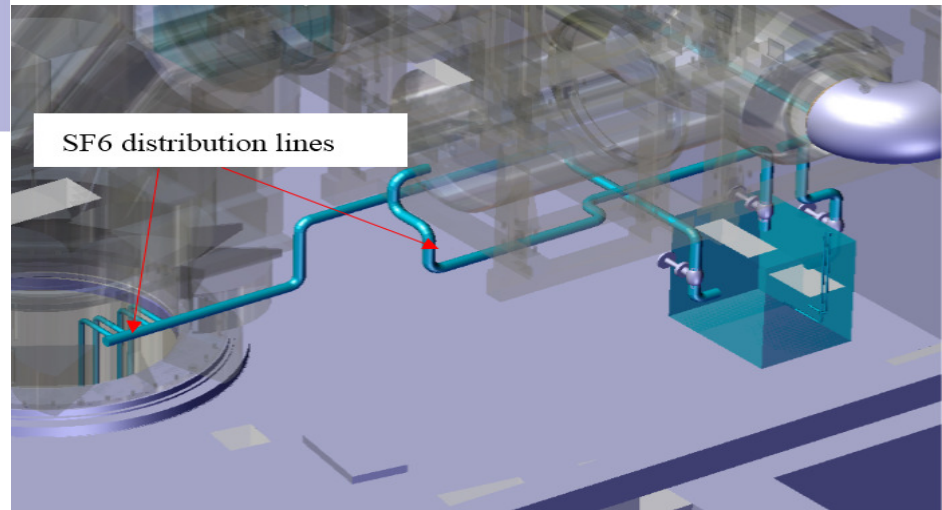

## Diagnostic systems – Nuclear Building

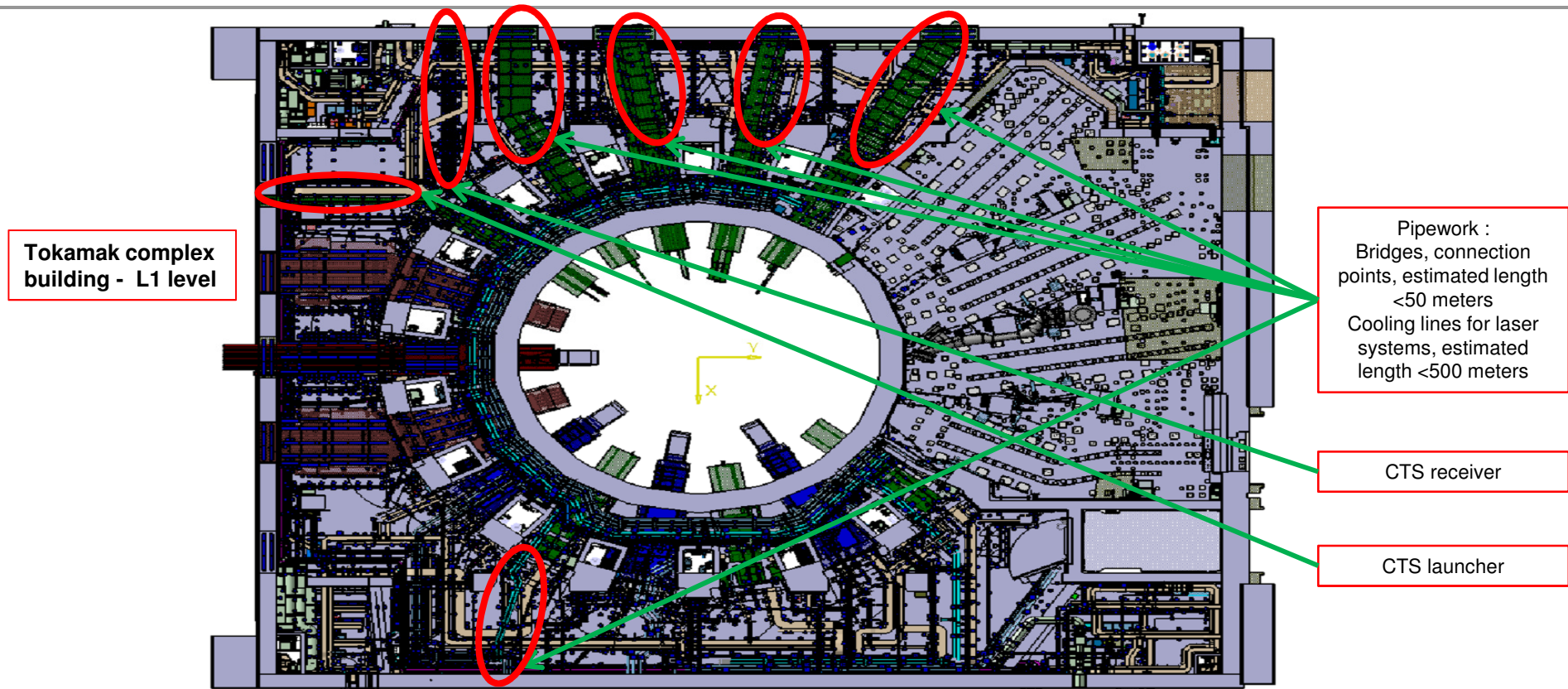



## Diagnostic systems – Nuclear Building

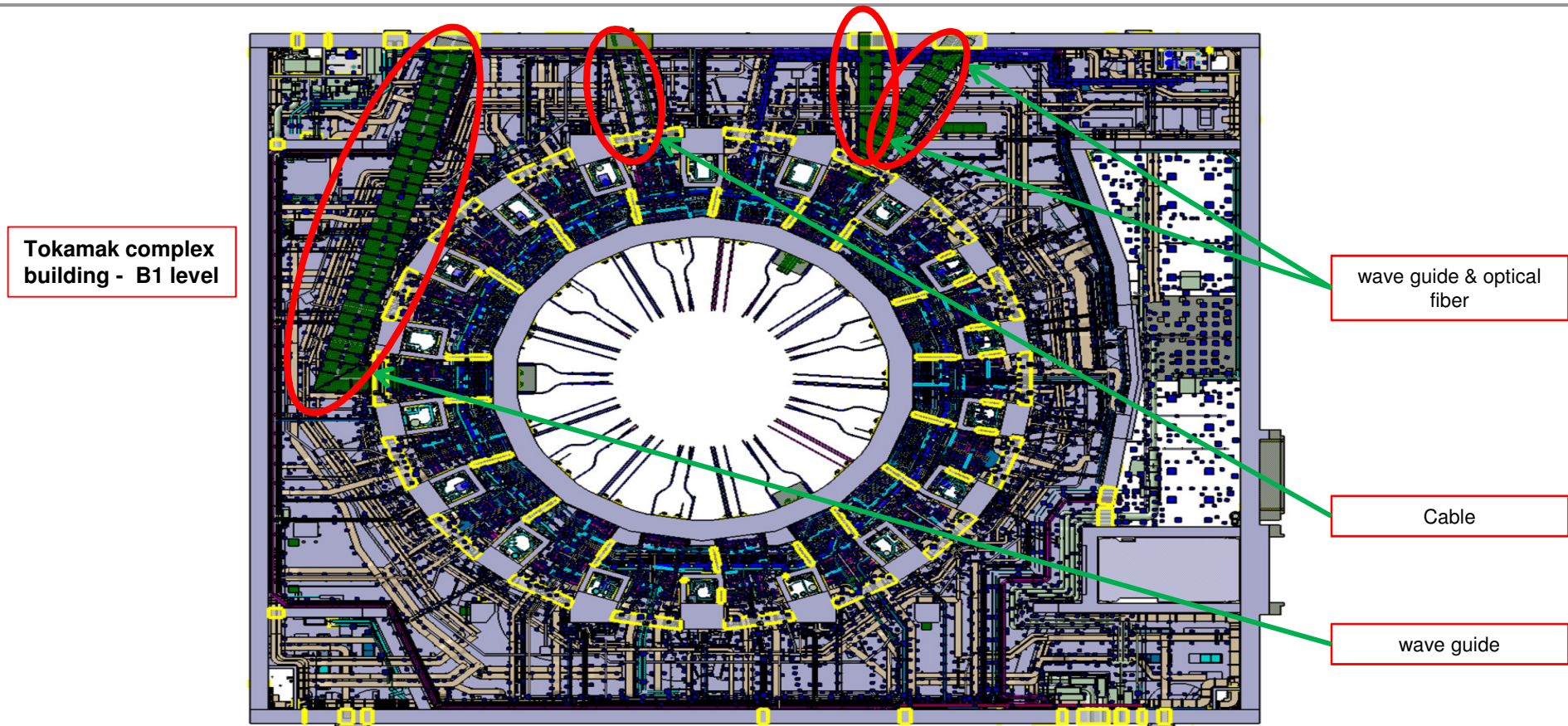

# Test Blanket Module System – Tokamak Complex Building

Only TBS Connection Pipes system is in the scope (red marked for coolant systems):

- ≈ 4 km of pipes + piping mechanical supports + steel supports + thermal insulation
- two water decay tanks

All equipment are PIC and are either pressure equipment (ESP) or nuclear pressure equipment (ESPN)

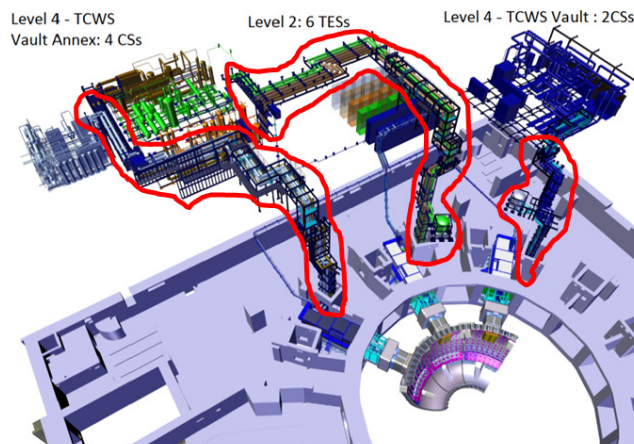

System	Material	Schedule	Size (mm)
TBS Connection Pipes for coolant systems	ASTM A312M GR.TP316L or RCC-MR Section 2, RM-3342 GR. 1.4404	80S to 160S	DN80 to DN100
TBS Connection Pipes for TES, TRS, TAS, NAS systems	ASTM A312M GR.TP316L or RCC-MR Section 2, RM-3342 GR. 1.4404	5S to 40S	DN15 to DN50
TBS Connection Pipes for CCWS-1	ASTM A312M GR.TP316L	160S	DN100 to DN250
Steel metallic supports	Stainless Steel 304		

## Radioactive waste treatment and storage system piping

Overview of waste treatment pipes at B2 in  
Tokamak Building Complex  
Length around 200m

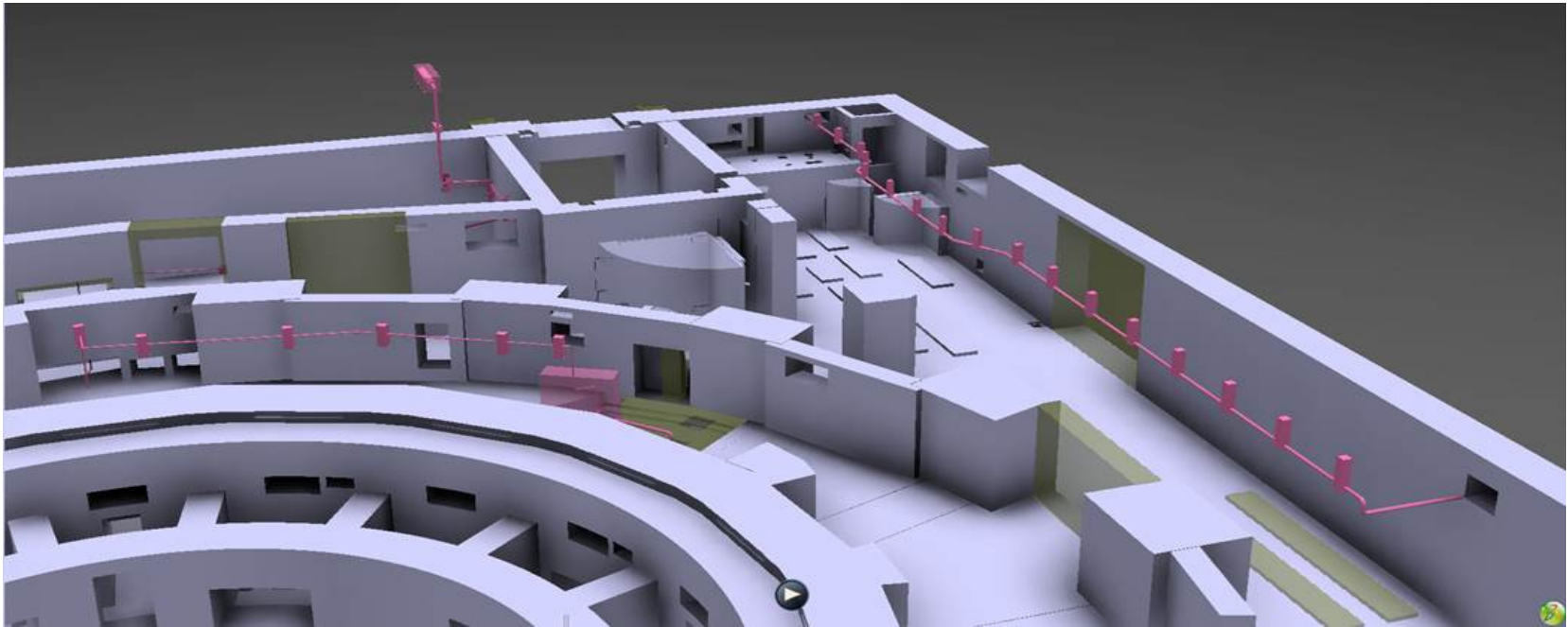

## Radioactive waste treatment and storage system piping

---

Type A Rad waste System (RWST) - Seamless pipe (Piping Outside Bio-shield & Cryostat)			
System	Material	Schedule	Size (mm)
Type A - RWST	ASTM A312M GR.TP304L	40S	DN50



## Various scope of installation works

---

Steel structure for platforms, walkways and piping supports			
Material	Material	Quantity (kg)	
Steel structure for piping supports	Carbon steel and stainless steel	To be estimated	
Steel structure for platforms	Structural Carbon steel	5000 m2	

Building Services			
System	Length	Material	Size (mm)
Liquid and Gas pipes HVAC ducts Drainage Fire protection	1000 m	Carbon steel and stainless steel	DN20 to DN150

# Procurement strategy

---

Overview of the procurement strategy related to the installation works		
Material	Volume (% of total length of pipe)	
Pipe raw material	10%	
Spool prefabrication	60%	
Steel structure for piping supports	60%	
Support prefabrication	60%	
Steel structure for platforms	100%	
Thermal insulation	90%	
Paint / coat	90%	
Anchors	50%	

# OPTION - Cryoplant – Cryo Buildings

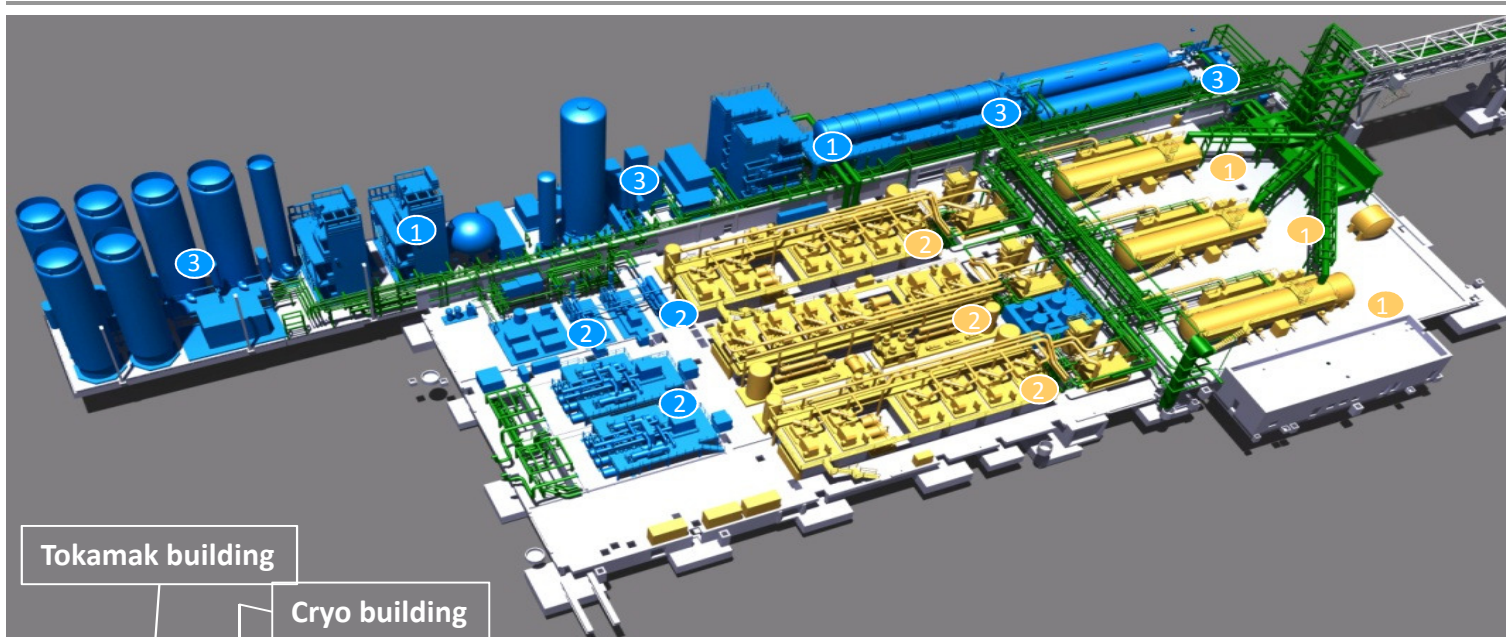

Only LN2 plant (blue) is part of the scope as an option

Liquid helium (LHe) Plants cold boxes ① and Compression station ②

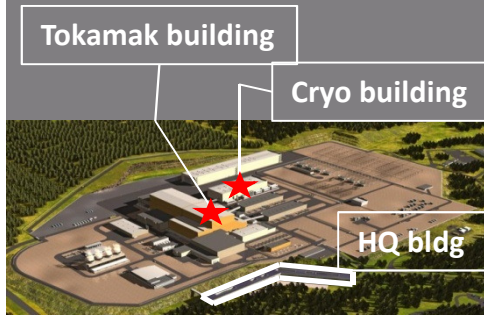

Cryolines & Cryoplant Termination Cold Box (CTCB)

Liquid nitrogen (LN2) plant and auxiliary system  
 Cold boxes ①    Compressors ②    Tanks ③