

Technical Specifications (In-Cash Procurement)

**Technical Specification for the seismic qualification of
CHWS-H1 SIC chillers**

Technical Specification for the seismic qualification of CHWS-H1 SIC chillers

Technical Specification for the seismic qualification of CHWS-H1 SIC chillers

Table of Contents

1	PURPOSE	4
2	DEFINITIONS	4
3	INTRODUCTION.....	5
3.1	The ITER Project	5
3.2	ITER Cooling Water System (CWS)	5
3.3	Chilled Water System (CHWS-H1)	6
4	SCOPE OF WORK.....	8
5	WORK DESCRIPTION.....	8
5.1	Task 1	8
5.2	Task 2	9
5.3	Task 3	10
5.4	Task 4	11
6	ESTIMATED DURATION	11
7	INPUT DATA.....	12
8	RESPONSIBILITIES	12
8.1	IO Responsibilities	12
8.2	Contractor’s responsibilities and requirements	12
9	WORK MONITORING / MEETING SCHEDULE	13
10	LIST OF DELIVERABLES AND DUE DATES	13
11	ACCEPTANCE CRITERIA.....	14
12	NON-DISCLOSURE CONDITIONS.....	14
13	CONTRACTOR’S QUALIFICATION	14
14	SAFETY REQUIREMENTS	15
15	REFERENCES.....	15
16	ANNEX A- FLOOR RESPONSE SPECTRA AT L4 BUILDING 74.....	16
17	ANNEX B - GENERAL ARRANGEMENT (GA) DRAWINGS ON THE ROOF OF BUILDING 74	21

List of Figures

Figure 1 - Heat transfer among systems of ITER CWS.....	6
Figure 2 - CHWS-H1 train B located on the roof of Building 74.....	7
Figure 3 - Chillers of CHWS-H1 train B located on the roof of Building 74.....	8
Figure 4 - Reference dimension of the CHWS-H1 chillers	10
Figure 5 - Reference data of the CHWS-H1 chillers	10
Figure 6 - Location of nodes for the FRS calculation.....	16
Figure 7 - Location of node 68900 for the FRS calculation	16
Figure 8 - FRS x direction at Node 68900	17
Figure 9 - FRS y direction at Node 68900	17
Figure 10 - FRS z direction at Node 68900	18
Figure 11 - Location of node 68962 for the FRS calculation	19
Figure 12 - FRS x direction at Node 68962	19
Figure 13 - FRS y direction at Node 68962	20
Figure 14 - FRS z direction at Node 68962	20

1 Purpose

The purpose of this contract is to assess the needs for qualifying the SIC Chillers of CHWS-H1 to be installed on the roof of the Diagnostic Building 74 at IO site against seismic accelerations that in vertical direction could reach peaks of 75 m/s² in the range of frequency of about 5-10 Hz. The CHWS-H1 system is in the IN DA procurement scope but the eventual qualification and installation has to be performed by IO Central Team.

2 Definitions

BoQ: Bill Of Quantity

CCWS: Component Cooling Water System

CHWS: Chilled Cooling Water System

CVCS: Chemical and Volume Control System

CWS: Cooling Water System

DR: Draining & Refilling system

DTR: Drain Tank Room

DY: Drying System

EDS: Energy Dissipation System

EP: Embedded Plates

FRS: Floor Response Spectra

GA: General Arrangement drawing

HCC: Hot Cell Complex

HRS: Heat Rejection System

IBED: Integrated Blanket / ELMs / Divertor

IN DA: India Domestic Agency

INB: Installation Nucléaire de Base

KoM: Kick off Meeting

NBI: Neutral Beam Injector

PIA: Protection Important Activities

PIC: Protection Important Components

PFD: Process Flow Diagram

PHTS: Primary Heat Transfer System

P&ID: Piping and Instrumentation Diagram

QC: Quality Class

RO: Responsible Officer

SC: Seismic Class

SI: Seismic Isolator

SIC: Safety Important Component

SR: Safety Relevant

TCWS: Tokamak Cooling Water System

US DA: US Domestic Agency

VV: Vacuum Vessel

VVPSS: Vacuum Vessel Pressure Suppression System

WBS: Work Breakdown Structure

For a complete list of ITER abbreviations see: [ITER Abbreviations \(ITER_D_2MU6W5\)](#).

3 Introduction

3.1 The ITER Project

The ITER project aims to demonstrate the scientific and technological feasibility of fusion power for peaceful purposes and to gain the knowledge necessary for the design of the next stage device.

The ITER project is organized as an international research and development project jointly funded by its seven Members: the European Union (represented by EURATOM), Japan, People's Republic of China, India, Republic of Korea, Russian Federation and the USA.

ITER is being constructed in Europe, at Cadarache in southern France, which is also the location of the headquarters of the ITER Organization (IO).

During ITER construction, most of its components will be supplied “in-kind” by the ITER Members. These in-kind contributions are being managed through a Domestic Agency (one per ITER Member) located within the Member's own territory.

The official language of the ITER Project is English.

More details about the Project Organization, The Domestic Agencies, the IO location and other different aspects of the Organization are available on the website: www.iter.org.

3.2 ITER Cooling Water System (CWS)

The ITER Cooling Water System (CWS) consists of the Tokamak Cooling Water System (TCWS), the Component Cooling Water System (CCWS), the Chilled Water System (CHWS), and the Heat Rejection System (HRS)

TCWS is designed to reject all the heat generated in the plasma and transmitted to the in-vessel components to the intermediate closed loop Component Cooling Water System (CCWS-1) and then to the environment via the open Heat Rejection System (HRS). In particular, during the D-T Plasma phase, the heat transmitted and generated in the in-vessel component (IVCs) will be transferred, through the Primary Heat Transfer Systems (PHTSs) to the intermediated closed Component Cooling Water System (CCWS-1) and then, via the open loop Heat Rejection System (HRS), to the environment.

The HRS also absorbs heats through the CCWS-2 from other non-nuclear systems like the Chilled Water System (CHWS), the Cryogenic System, the Steady State Electrical Power Network (SSEPN) and other auxiliary systems. The CCWS-2 is further divided in CCWS-2A, 2B, 2C, and 2D to provide separated chemical control and prevent galvanic corrosion among the different material (SS, Cu, Al) of the clients' components. CHWS is divided in CHWS-H1 for SIC systems and CHWS-H2 for non-SIC components. The HRS rejects all the heat from ITER components (nuclear and non-nuclear) to the environment.

The total heat load to be removed at reference plasma operation by the CWS is above 1200 MW with the following single design requirements (excluding contemporary operations but including margin):

- TCWS to be designed for about 1100 MW – 4600 kg/s;
- CCWS-1 to be designed for about 982 MW – 5800 kg/s;

- CCWS-2 to be designed for about 164 MW – 4300 kg/s with the:
 - CCWS-2A to be designed for about 40 MW – 900 kg/s;
 - CCWS-2B to be designed for about 28 MW – 1100 kg/s;
 - CCWS-2C to be designed for about 6 MW – 160 kg/s;
 - CCWS-2D to be designed for about 90 MW – 2150 kg/s;
- CHWS-H1 to be designed for about 2.2 MW – 90 kg/s;
- CHWS-H2 to be designed for about 27.5 MW – 1100 kg/s;
- HRS to be designed for about 500 MW – 10500 kg/s.

The relationship among the above stated subsystems is shown in Figure 1.

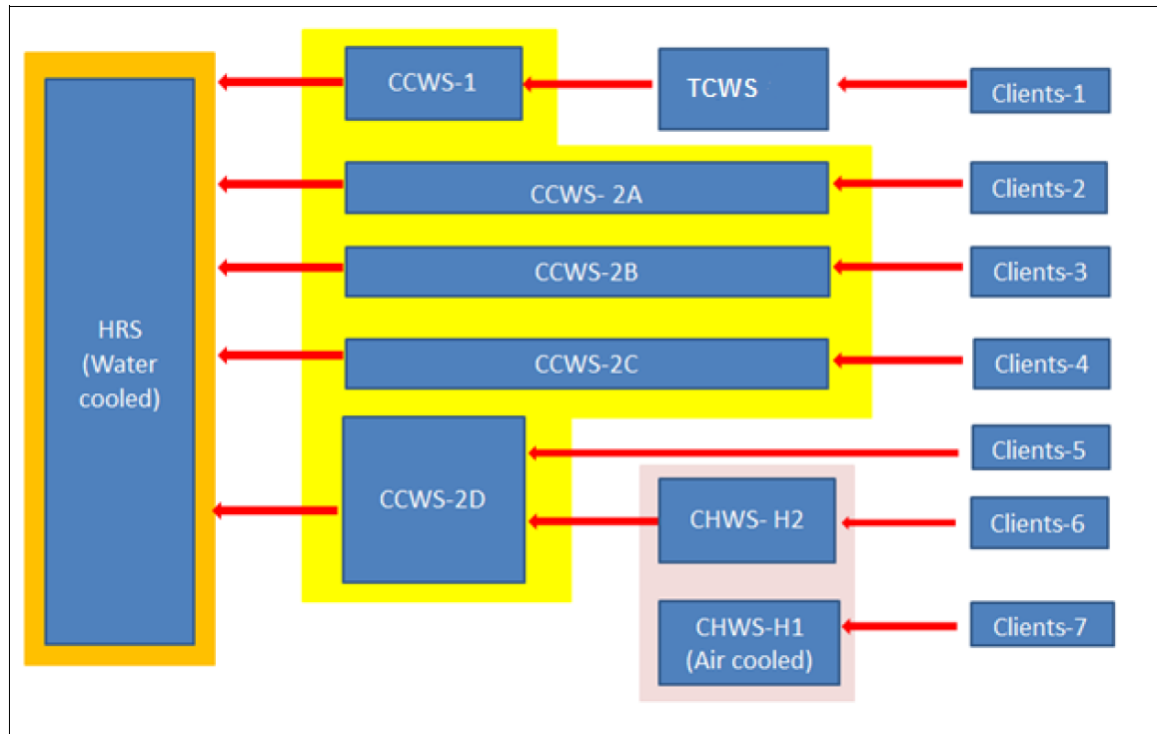

Figure 1 - Heat transfer among systems of ITER CWS

3.3 Chilled Water System (CHWS-H1)

The function of the CHWS-H1 - safety-related closed loop chilled water system - is to provide cooling water at 6°C to Safety Important Components (SIC) and transfer the heat directly from them to the atmosphere through air-cooled condensers.

CHWS-H1 is also classified as Seismic Class 1 (SC- 1) and Quality Class 1 (QC-1).

SIC components are designed to withstand all loads and conditions resultant from any design basis situations including normal operations and any incidental and accidental situations during and after which SIC elements shall continue in accomplishing their accredited safety functions. Loads and load combinations for Cooling Water System are provided in the document.

CHWS H1 piping that penetrates a confinement barrier is designed to ensure that the confinement function of the barrier is maintained during and after a design-basis event, including a seismic event.

The CHWS-H1 safety-related closed loop chilled water system serves the Detritiation System, the Local Air Coolers-SIC (LACs) of the Hot Cell Building and Tokamak building, the VV PHTS and Helium coolant system. All of these systems are SIC. Direct air cooling is adopted

for the condensers in chiller units using air cooled condensers. CHWS-H1 is provided with 100% redundancy by two independent air cooled chiller trains designated as H1A and H1B.

Each independent train of CHWS-H1A and CHWS-H1B comprises of three/four air cooled chillers, three/four chilled water circulating pumps and a pressurizer. The equipment of CHWS-H1A and CHWS-H1B are located respectively on the roofs of the Hot Cell Building (Building 21) and the Diagnostic Building (Building 74) and connected with interlinking supply and return header which crosses through Tokamak complex. The Figure 2 and Figure 3 show the configuration of CHWS-H1 train B and relevant chillers located on the roof of Building 74.

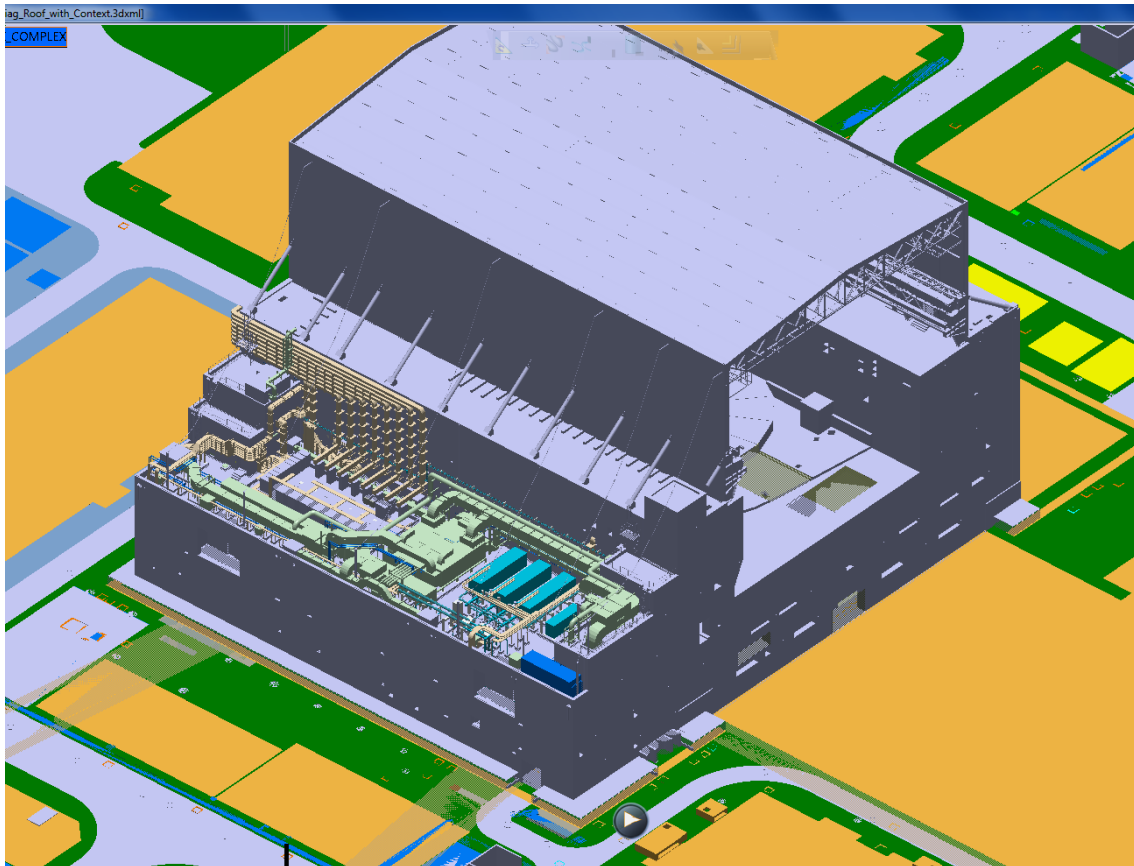

Figure 2 - CHWS-H1 train B located on the roof of Building 74

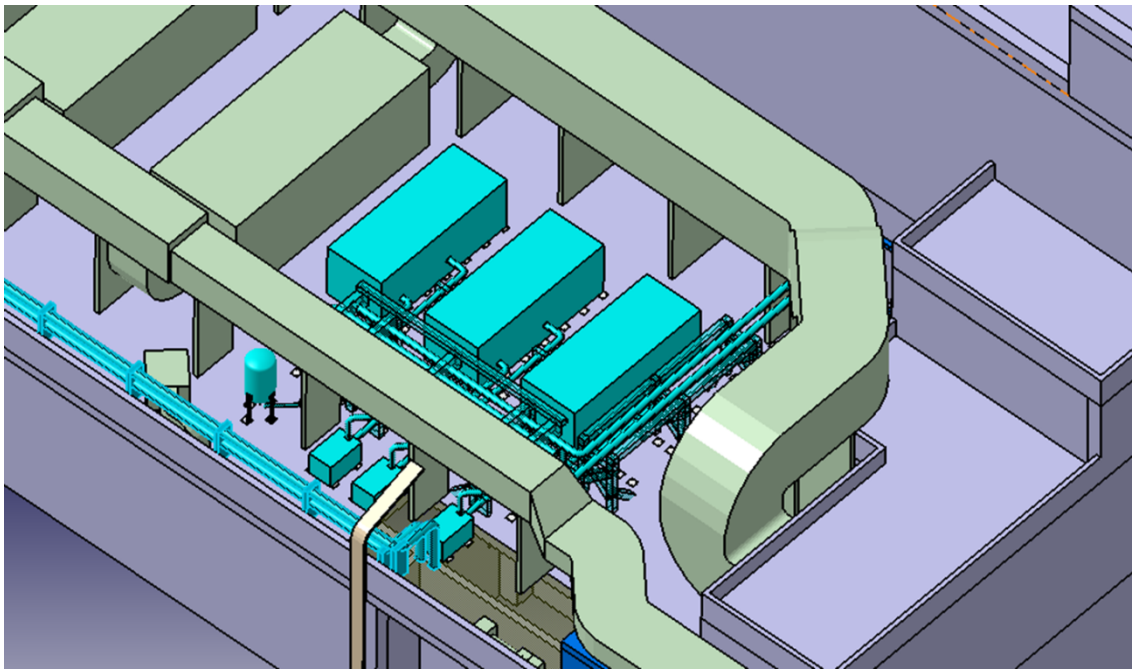

Figure 3 - Chillers of CHWS-H1 train B located on the roof of Building 74

4 Scope of work

The scope of work is to perform the following 4 tasks for the IO CWS for the seismic qualification of ITER CHWS-H1 SIC chillers:

- Task 1. To assess the effect of the building FRSs and the relevant design condition for the CHWS-H1 train B Chillers located on the roof of Diagnostic Building 74 at IO site;
- Task 2. To perform the conceptual design the Seismic Isolators (SI) and/or Energy Dissipation System (EDS) integrated on a metallic structure suitable for this application;
- Task 3. To provide guidance for the procurement of qualified SI and relevant support steel structure to anchor the chillers on the roof slabs;
- Task 4. To suggest IO CT suitable Labs for performing the necessary experimental tests for the relevant chillers with SI and supporting frames;

5 Work Description

The activities to be carried out by the Contractor are listed in the following Sections. The Contractor shall provide separated quotations for each Task.

5.1 Task 1

This task is to assess the effect of the building FRSs and the relevant design conditions for the CHWS-H1 train B Chillers located on the roof of Diagnostic Building 74 at IO site.

The main aim of this task is to define the strategy and the limits for designing a proper system, based on Seismic Isolators (SI), to damp the seismic effect on the chiller structures transmitted by the buildings considering the reference seismic loads scenario [1].

The available Floor Response Spectra FRSS [2-3] are reported in the ANNEX A- Floor Response Spectra at L4 Building 74 for two specific nodes close to the location of the CHWS-H1 train B Chillers on the roof of Diagnostic Building 74.

The FRSS curves in the Annex A also show the maximum acceptable vertical acceleration of 20 m/s² or 2 g and also the proposed range of resonance frequency of the chillers' skid provided with SI.

The Contractor shall consider the limitation of the acceleration on the commercial chillers on the market qualified to resist to a maximum vertical acceleration of 20 m/s² or 2 g.

The Contractor shall assess the suitable range of resonance frequency of the chillers' skid, provided with SI, which shall be assumed for the relevant design solution object of the Task 2 and 3.

5.2 Task 2

To perform the conceptual design the Seismic Isolators (SI) and/or Energy Dissipation System (EDS) integrated on a metallic structure suitable for this application;

The main aim of this task is to propose a selection of suitable SI and/or EDS and to prepare a conceptual design solution about the integration of these systems on the steel structure suitable for this application. This steel structure shall be installed underneath the chiller skid and properly anchored on the plinths available on the roof of Building 74.

The reference dimension and main data of the CHWS-H1 chillers are reported in the Figure 4 and Figure 5.

The General Arrangement (GA) drawings of the on the plinths available on the roof of Building 74 are reported in the ANNEX B - General Arrangement (GA) drawings on the roof of Building 74.

The Contractor shall justify the selected solution with the indication of pro/cons among different alternatives (e.g. elastomeric, wire ropes, viscose elastic, sliding etc.) also indicate the range of cost for each solution.

The Contractor shall consider the geometrical limitations of the plinths and the number, dimensions and pitch of the available Embedded Plates (EP) to be used to support the steel structure.

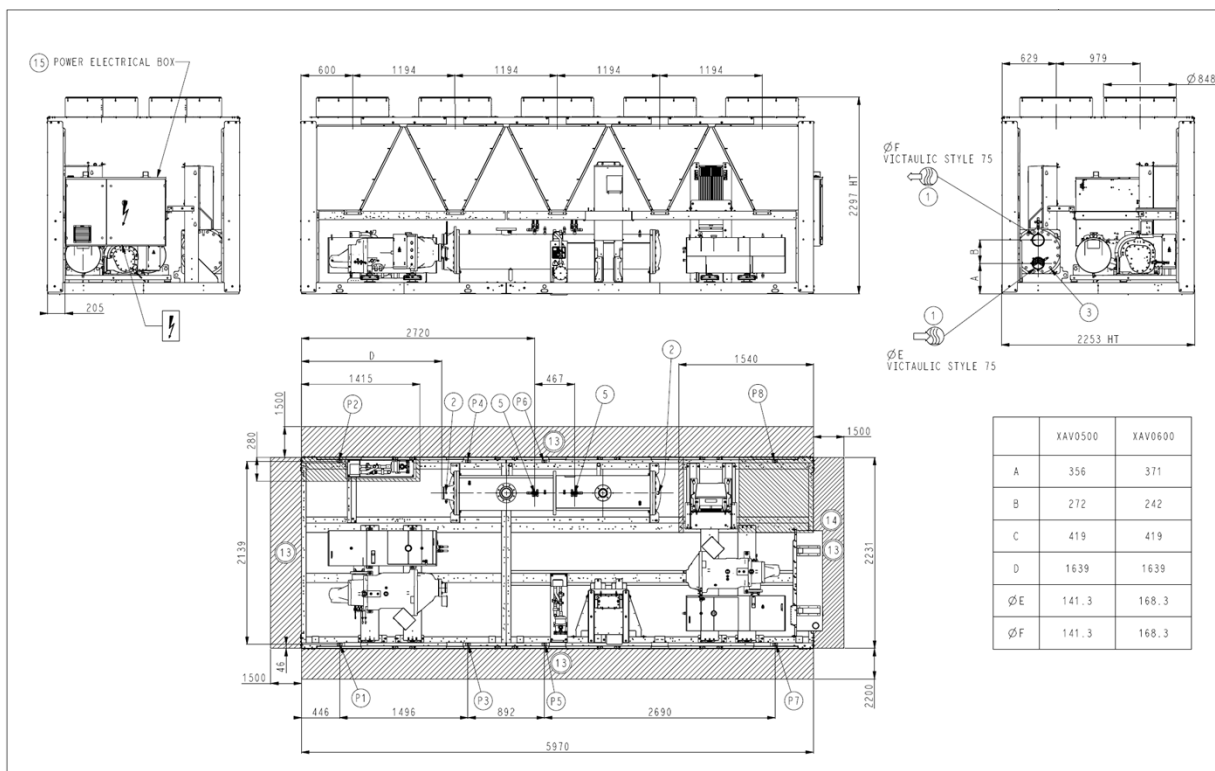

Figure 4 - Reference dimension of the CHWS-H1 chillers

Cooling Mode

Performance Information

Cooling Capacity: **507.6** kW
 Cooling Efficiency (EER): **2.41** kW/kW
 Seasonal Efficiency (ESEER): **4.66** kW/kW
 Unit Power Input: **210.73** kW

Evaporator Information

Fluid Type: **Fresh Water**
 Fouling Factor: **0.1760** (sqm-K)/kW
 Number of Passes: **2**
 Leaving Temperature: **6.0** °C
 Entering Temperature: **12.0** °C
 Fluid Flow: **20.19** l/s
 Total Pressure Drop: **16.3** kPa

Condenser Information

Altitude: **0** m
 Number of Fans: **10**
 Entering Air Temperature: **45.0** °C

Acoustic Information (cooling mode)

Sound Power Level (LwA): **103** dB(A)
 Sound Pressure Level at 10.0m (LpA): .. **70** dB(A)

Unit Information

Manufacturing Source: **Montluel, France**
 Refrigerant: **R-134a**
 Minimum Capacity: **10** %
 Number of Refrigerant Circuit: **2**
 Operating/Shipping Weight: **5220/5130** kg
 Unit Dimensions (LxWxH): **6092/2253/2297** mm

MCHE Coating Requirements Information

Distance from coast (km): **0.5** km
 Average Annual Temperature: **35.0** °C
 Average Annual Relative Humidity: **75.0** %

Electrical Information

Unit Voltage: **400(+/-10%)-3-50** V-Ph-Hz
 Standby Power: **0.15** kW
 Power Factor: **0.92**

Amps (Un)	Electrical Circuit 1	Electrical Circuit 2
Maximum Current In (A):	400	None
Start Up Current (A)	<RLA	---
Current at Eurovent Conditions (A)	306	None

Figure 5 - Reference data of the CHWS-H1 chillers

5.3 Task 3

To provide guidance for the procurement of qualified SI and relevant support steel structure to anchor the chillers on the roof slabs.

The Contractor shall select, from suitable catalogues, the SI and/or EDS proposed in the Task 2 and to prepare data sheet, drawings and Bill Of Quantity (BoQ) ready to execute the purchase.

The Contractor shall also select the suitable standard steel beams designed to support the SI and/or EDS as proposed in the Task 2 and to prepare data sheet, drawings and Bill Of Quantity (BoQ) ready to execute the purchase.

The Contractor shall indicate the range of cost of the selected components.

5.4 Task 4

To suggest IO CT suitable Labs for performing the necessary experimental tests for the relevant chillers with SI and supporting frames;

The Contractor shall select, from existing suitable Labs, the ones available to perform a proper seismic qualification in the range of accelerations, displacements and loads.

The Contractor shall prepare a detailed technical specification of the tests to be performed as well as the forecast of the time durations of these tests.

The Contractor shall also indicate the range of cost of these tests and the suitable time to perform them.

6 Estimated Duration

The total estimated duration will be 4.5 months. The starting date of the service shall be the signature of the contract, the implementation of the tasks shall start at the Kick off Meeting to be held by parties within 2 weeks of the contract signature (also defined at T0). The expected durations of each individual task are the following:

Task	Description	Estimated time for completion (unit M=Month(s))
1	Assess the effect of the building FRSs and the relevant design condition for the CHWS-H1 train B Chillers located on the roof of Diagnostic Building 74 at IO site	0.5M
2	Perform the conceptual design the Seismic Isolators (SI) and/or Energy Dissipation System integrated on a metallic structure suitable for this application	2.0M
3	Provide guidance for the procurement of qualified SI and relevant support steel structure to anchor the chillers on the roof slabs	0.5M
4	Suggest IO CT suitable Labs for performing the necessary experimental tests for the relevant chillers with SI and supporting frames	0.5M

Table 1 - Estimated duration of the Tasks

7 Input Data

IO will provide to the Contractor the following documents:

- FRSs of building 74 – [2]-[3] See ANNEX A- Floor Response Spectra at L4 Building 74;
- 3D models (using 3dxml, 3dvia or Aveva PDMS/E3D);
- General Arrangement Drawings (in PDF and/or AutoCad DWG) [6] see ANNEX B - General Arrangement (GA) drawings on the roof of Building 74;
- Documents on CHWS-H1 systems sizing calculation, Data Sheets and other available information or concerned technical data as received from IN DA and relevant subcontractors and vendors.

8 Responsibilities

8.1 IO Responsibilities

IO shall assign one IO representative, to work as sole Contractor interface. The IO representative will assess the performance and quality of the work.

The IO representative shall be responsible for checking the deliverables against requirements and the schedule.

IO shall make available to the Contractor all technical data and documents which the Contractor requires to carry out its obligations pursuant to this specification in a timely manner. For delays of more than two weeks in making them available, the Contractor shall advise IO representative of the potential impact on the time for completion of the deliveries, to agree and define all the correction actions to take in place.

8.2 Contractor's responsibilities and requirements

The Contractor shall ensure that he complies with the provisions of the ITER IO Contract in particular with the following:

- The Contractor shall guarantee that all input information provided to perform the task remain property of IO and shall not be used for any other activity than the one specified in this specification;
- The Contractor shall provide an organization suitable to perform the work as describe in this specification;
- The Contractor shall perform the activities accordingly to this specification taking into account all relevant additional documents and IO processes into account (hand books, export control, intellectual properties, etc);
- The Contractor shall provide to the IO representative full access to its work premises and related documentation, to permit to follow up the progress of the work.

Prior to the start of work on each task, the Contractor shall review the input technical information provided to it by IO for completeness and consistency, and shall advise the IO representative of any deficiencies it may find. The Contractor shall not be responsible for errors in the input technical information which could not be reasonably detected during such review; duration of this review will be agreed between Contractor and IO representative and will have no impact on the delivery schedule.

9 Work Monitoring / Meeting Schedule

The Contractor and the IO shall have the first kick off meeting within 2 weeks from the signature of the contract. Once the tasks are commenced, the Contractor and the IO shall periodically meet to review the progress of the tasks and discuss technical issues at least once a month. The first of such Progress Meeting shall be held one month after the starting date. The Contractor shall report to the IO specifying the status of each activity and the relevant progresses made in the Tasks. During the Progress Meetings the activities of all the Tasks will be reviewed.

All the meetings shall be held typically by video-conference but for some specific necessity could be also arranged in person at a suitable location at the IO or Contractor premises.

The contractor or the IO can request additional meetings or communications to resolve issues.

10 List of deliverables and due dates

The lists of the deliverables and due dates for the relevant tasks are reported in the Table 2. The required time for the completion is expressed in months after the starting of the activities (T0).

T0 is the date of the kick off meeting to be held by both parties within 2 weeks from the contract signature.

Deliverable No	Task	DOCUMENT	Due Date (Unit M=Month(s))
D1	1	Report to assess the available FRs for building and the relevant design condition for the CHWS-H1 Chillers located on the roof of the Diagnostic building 74.	T0 + 0.5M
D2	2	Report for the conceptual design of the Seismic Isolators (SI) and/or Energy Dissipation System integrated on a metallic structure suitable for this application.	T0 + 2.5M
D3	3	Report to provide guidance for the procurement of qualified SI and relevant support steel structure to anchor the chillers on the roof slabs.	T0 + 3.0M
D4	4	Report to suggest IO CT suitable Labs for performing the necessary experimental tests for the relevant chillers with SI and supporting frames	T0 + 4.0M

Table 2 - List of deliverables and due dates

Ten days before the kick off meeting, the Contractor shall provide to IO for approval a detailed schedule to meet these delivery requirements.

The Contractor shall send, in advance to the milestones indicated in the Table 2, the electronic copy of the draft report to permit IO a preliminary evaluation of them.

11 Acceptance Criteria

The Contractor shall provide to IO the Deliverables corresponding to the Task assigned by IO in due time. The content of such Deliverables is described in Chapter 5.

Each Deliverable shall be based on a clear logical process, starting from the scope to the presentation and critical discussion of the results.

All deliverable shall be reviewed in the IDM system. A folder in IDM/DWM to store the output of each Task will be specified at the KoM.

Deliverables shall be considered complete after IO has issued formal acceptance. In case of non-compliance / conformity of a deliverable or a set of deliverables, the contractor shall correct them and re-submit them for review and acceptance; resubmission shall be at contractor's cost.

12 Non-disclosure conditions

The Contractor assigned to perform the services described under this specification must agree to abide by the following nondisclosure conditions:

- Not to disclose, deliver, or use for the benefit of any person other than the IO, or its authorized agents, any restricted or confidential information or material he or she receives from the IO, other than material or information previously in the records of the Contractor or obtainable prior to such disclosure, delivery, or use, from third parties or from the public domain, or required to be disclosed by law or court order.
- To adhere to any reasonable policies or instructions provided by the IO as to the classification, use or disposition of any restricted or confidential information or materials.
- Not to use any restricted or confidential information or material for personal gain.
- Because of Export License conditions the contractor shall not share the documentation related to this task outside the assigned team.

All the documentation provided as reference for this Technical Specification is subjected to the above conditions. During the contract deployment, unless clearly stated by IO, all documentation provided by IO will be subjected to the above conditions.

The Contractor further agrees to take such reasonable steps as may be needed to ensure that the terms of the nondisclosure statements are observed during and after the termination of the Services.

13 Contractor's qualification

The Contractor selected for the present activities has large experience in the specific field of design and qualification of Building structures and equipment with seismic isolators.

14 Safety requirements

ITER is a Nuclear Facility identified in France by the number-INB-174 (“Installation Nucléaire de Base”).

For Protection Important Components and in particular Safety Important Class components (SIC), the French Nuclear Regulation must be observed, in application of the Article 14 of the ITER Agreement.

In such case the Suppliers and Subcontractors must be informed that:

- The Order 7th February 2012 [4] applies to all the components important for the protection (PIC) and the activities important for the protection (PIA).
- The compliance with the INB-order must be demonstrated in the chain of external contractors.
- In application of article II.2.5.4 of the Order 7th February 2012 [4], contracted activities for supervision purposes are also subject to a supervision done by the Nuclear Operator.

For the Protection Important Components (PIC), structures and systems of the nuclear facility, and Protection Important Activities (PIA) the contractor shall ensure that a specific management system is implemented for his own activities and for the activities done by any Supplier and Subcontractor following the requirements of the French Order 7th February 2012 [4] - [5].

15 References

- [1] [Load Specification for Cooling Water System \(3YGYH7 v5.2\) \(current\)](#)
- [2] [Tokamak Complex - Floor Response Spectra 2016 - Esteyco \(TFN4DN v1.3\) \(current\)](#)
- [3] [Design Seismic Floor Response Spectra in the Tokamak Complex \(SVBRJZ v1.1\) \(current\)](#)
- [4] [French Order of 7th February 2012](#)
- [5] [Overall Surveillance Plan of External Interveners Chain for Protection Important Components, Structures and Systems and Protection Important Activities \(4EUQFL v6.1\) \(current\)](#)
- [6] [ITER PROJECT TKM COMPLEX- GENERAL ARRANGEMENT DRAWINGS \(DRAFT\) \(R7WFSB v1.0\) \(current\)](#)

16 ANNEX A- Floor Response Spectra at L4 Building 74

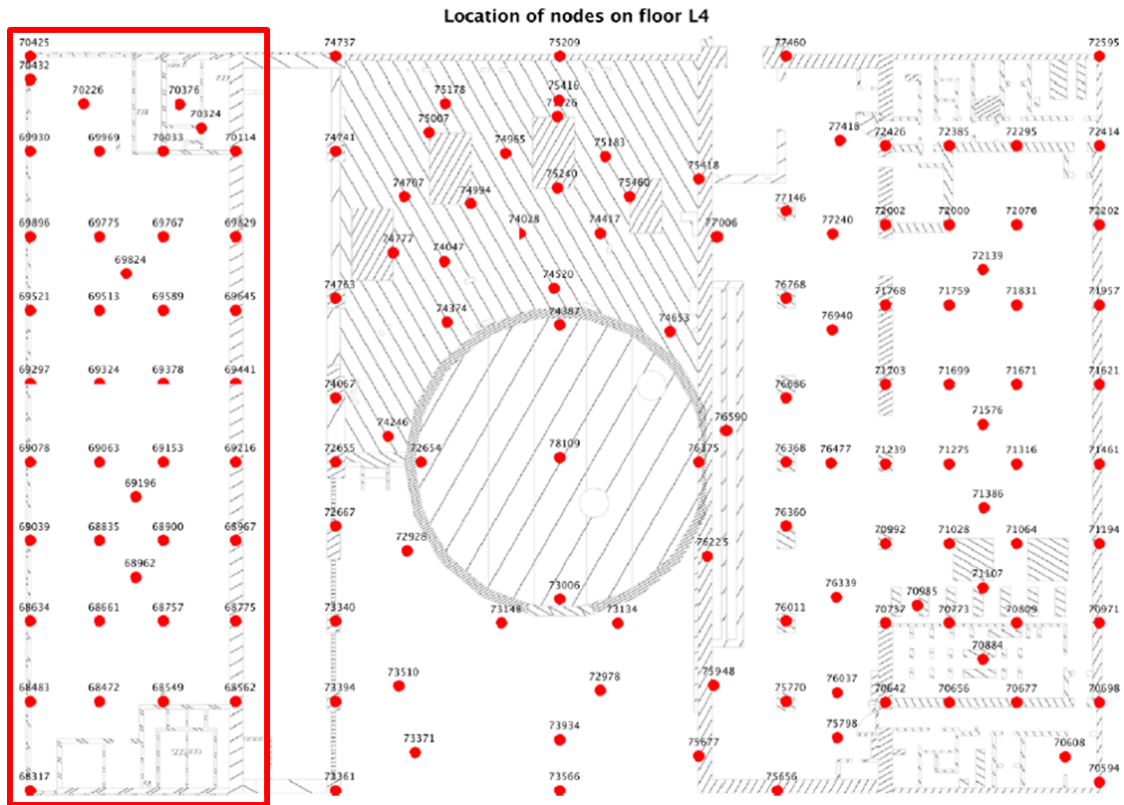

Figure 6 - Location of nodes for the FRS calculation

Node 68900 located in Building B74 Floor L4

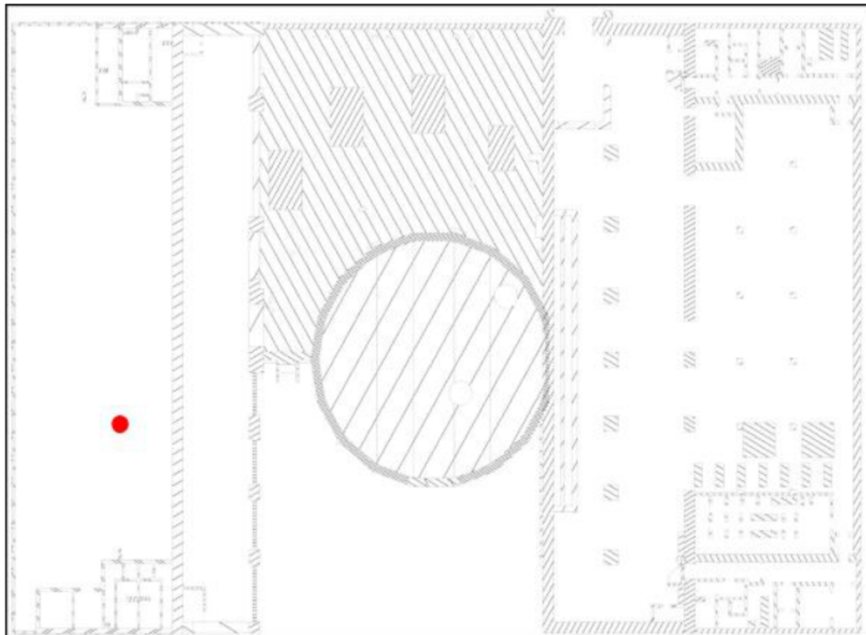

Figure 7 - Location of node 68900 for the FRS calculation

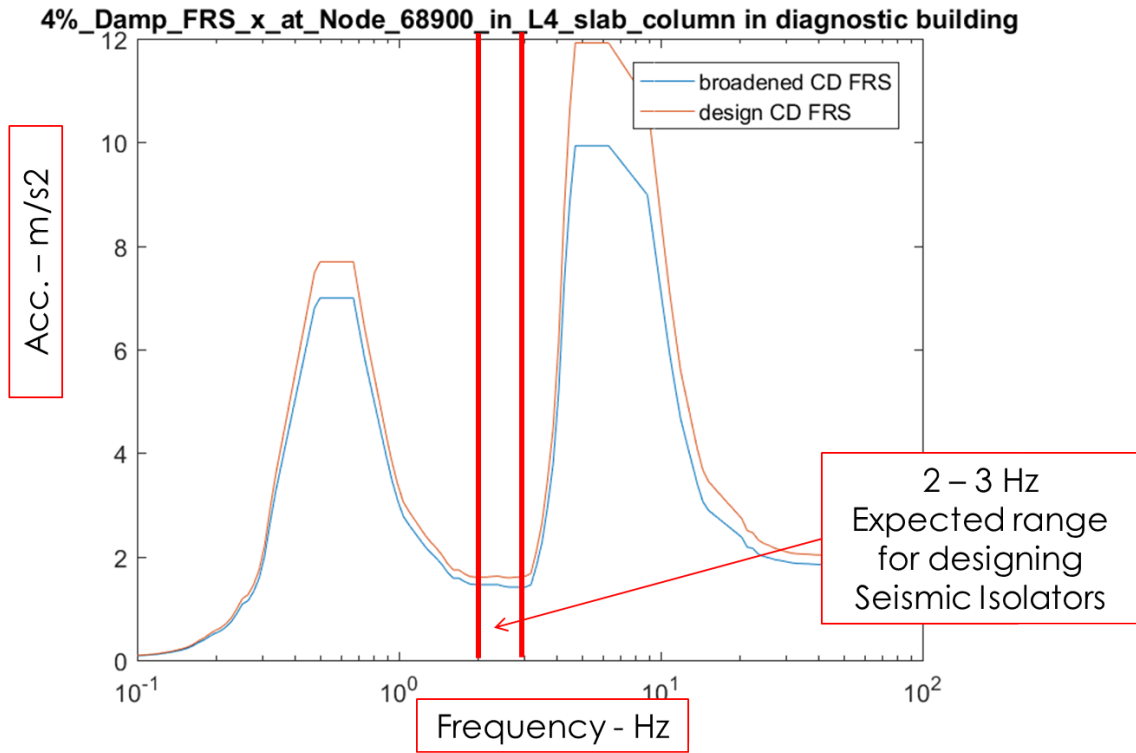

Figure 8 - FRS x direction at Node 68900

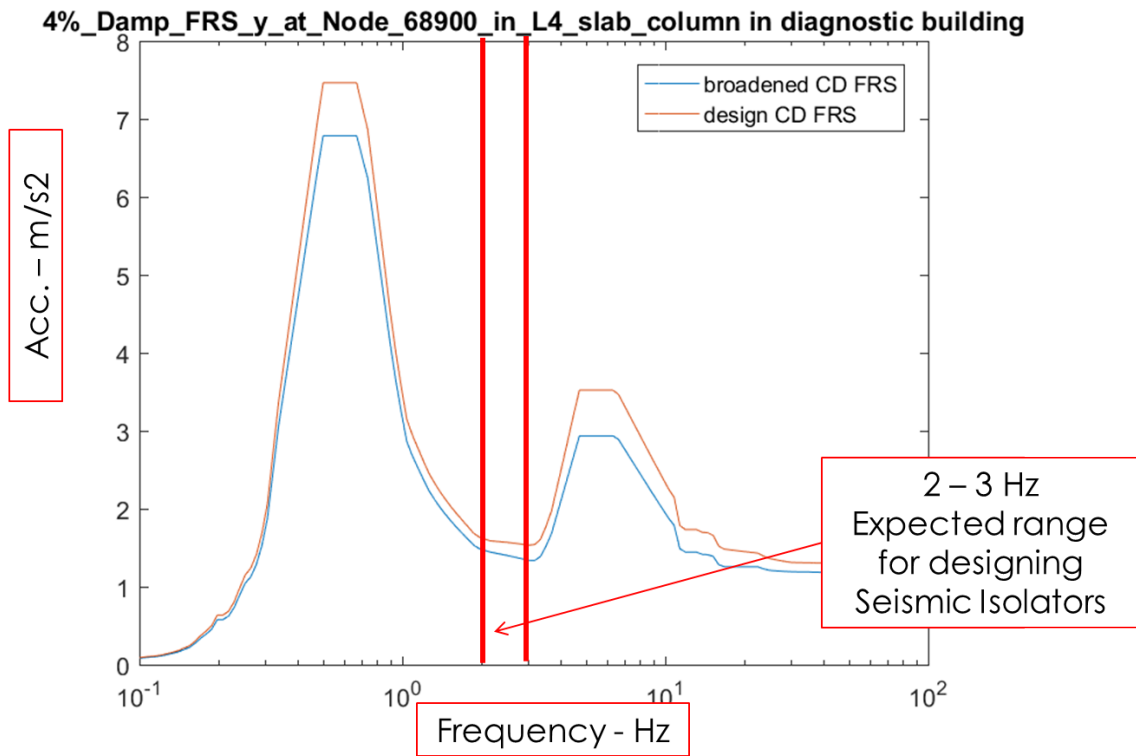

Figure 9 - FRS y direction at Node 68900

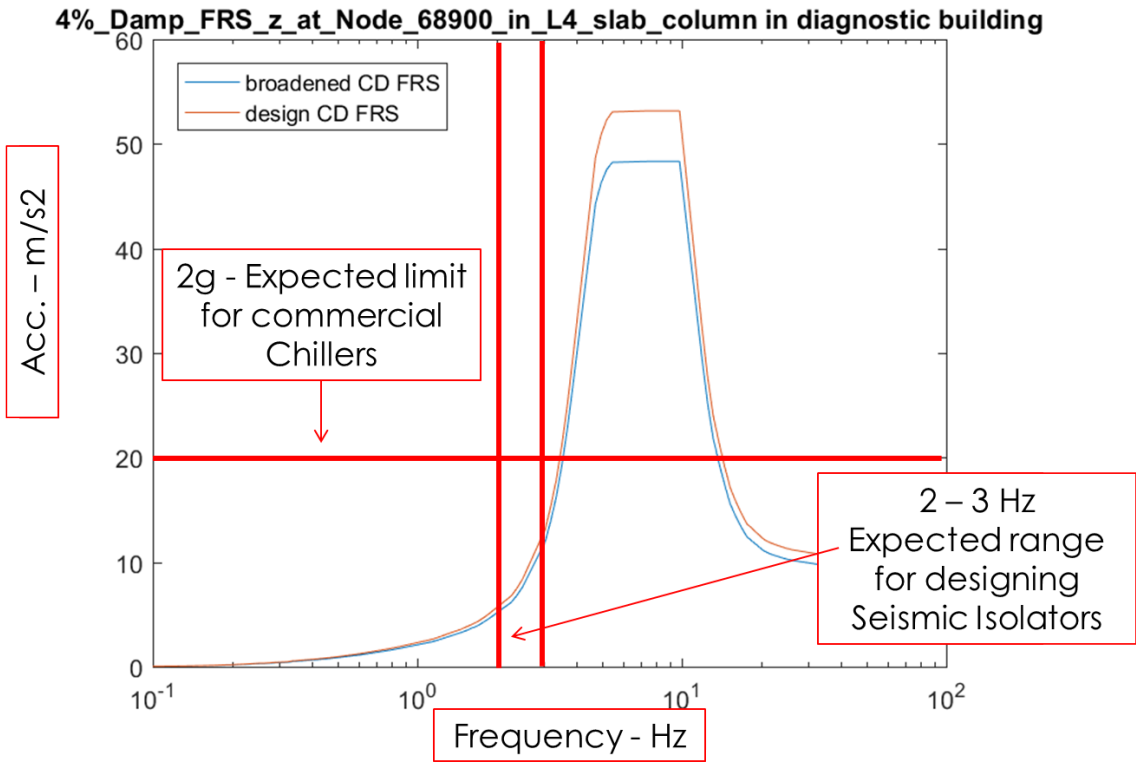

Figure 10 - FRS z direction at Node 68900

Node 68962 located in Building B74 Floor L4

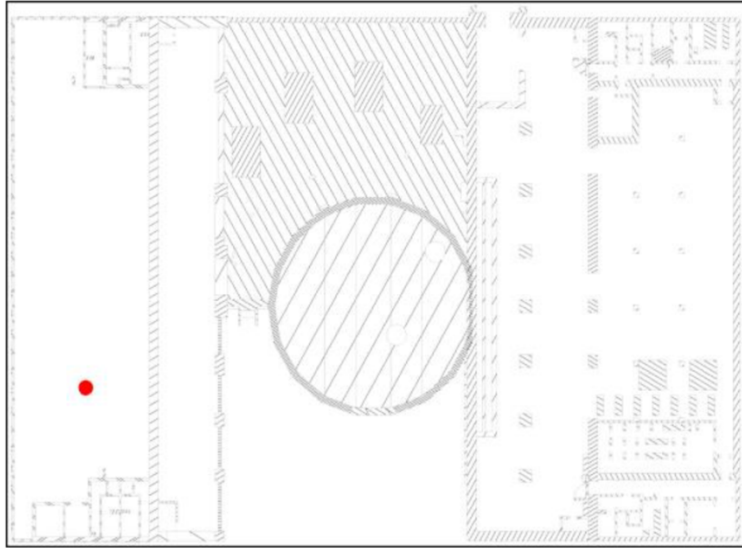

Figure 11 - Location of node 68962 for the FRS calculation

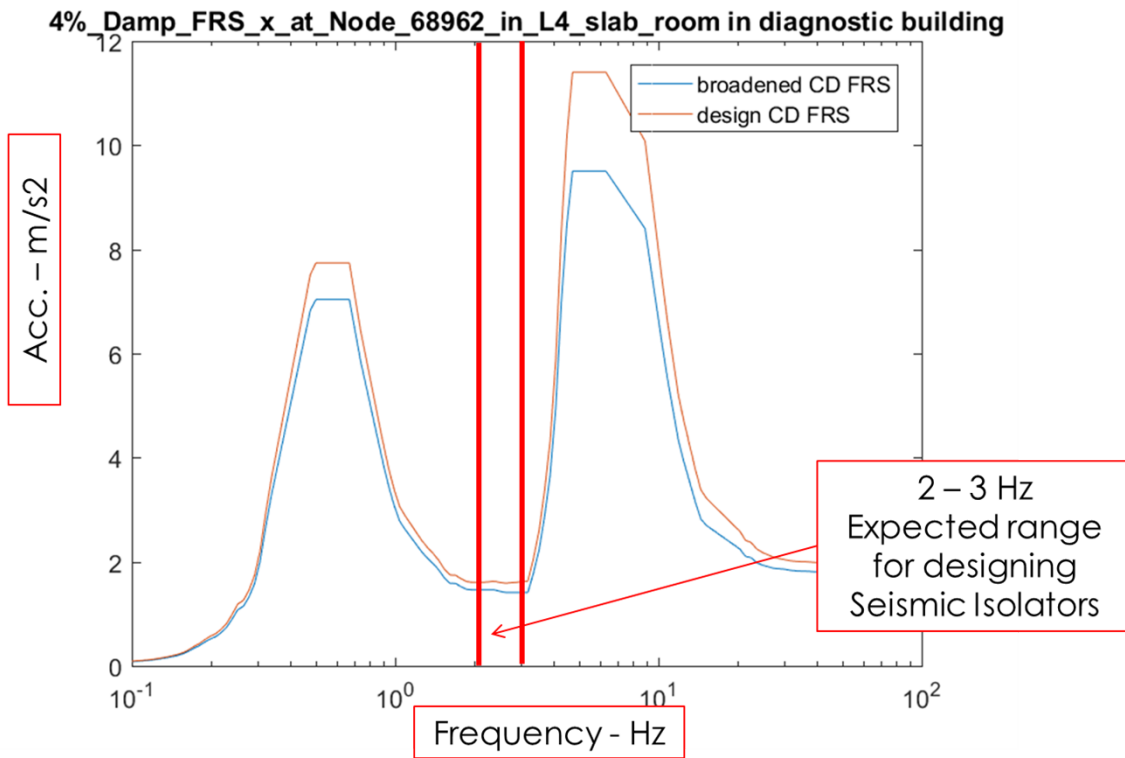

Figure 12 - FRS x direction at Node 68962

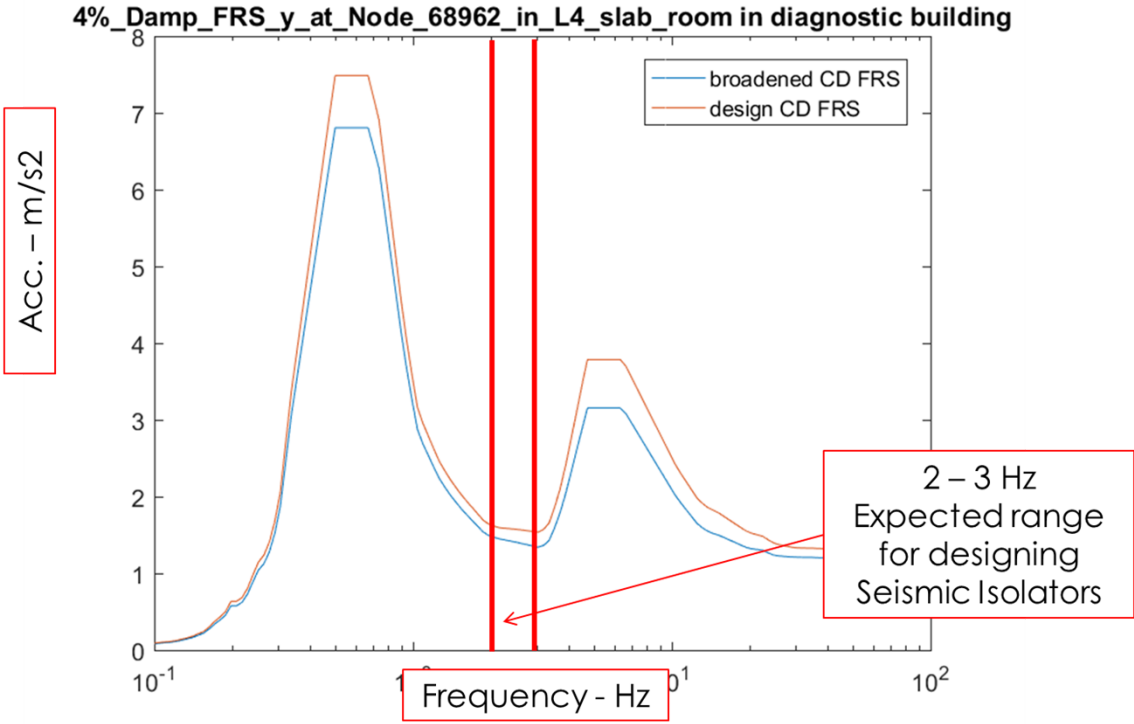

Figure 13 - FRS y direction at Node 68962

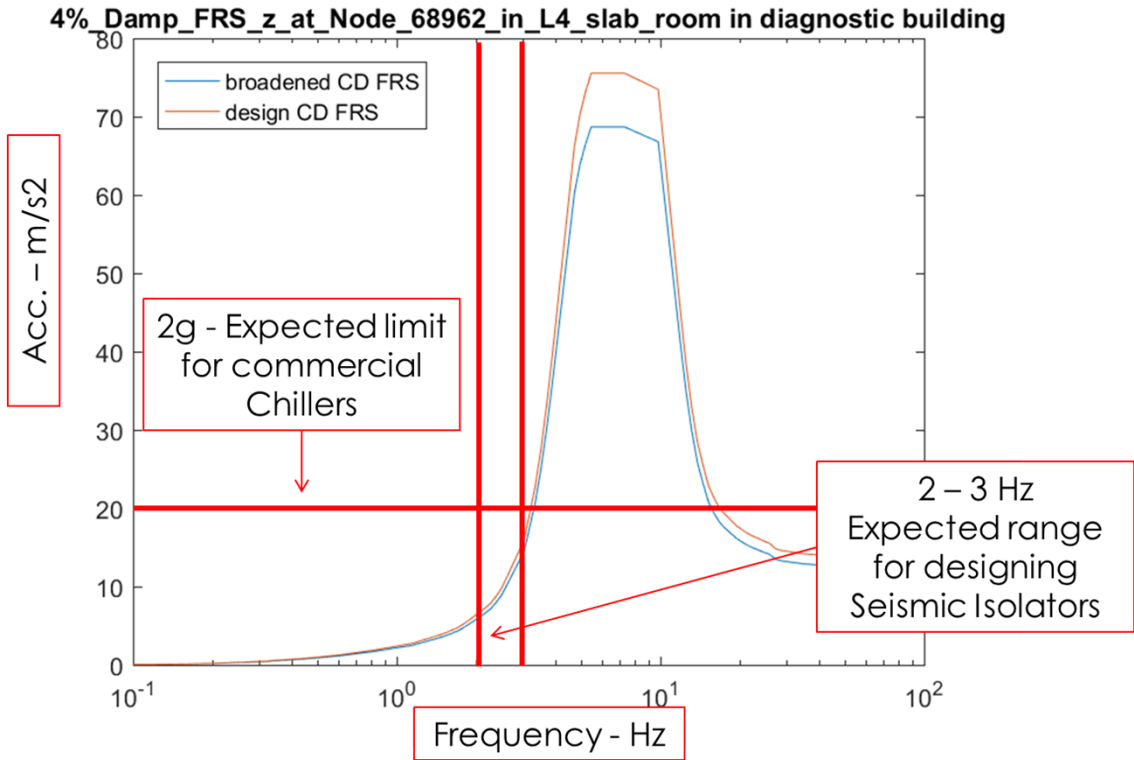

Figure 14 - FRS z direction at Node 68962

17 ANNEX B - General Arrangement (GA) drawings on the roof of Building 74

From [ITER PROJECT TKM COMPLEX- GENERAL ARRANGEMENT DRAWINGS \(DRAFT\) \(R7WFSB v1.0\) \(current\)](#)

